

User manual

Washer extractor

Wascator FOM71 CLS



Electrolux
PROFESSIONAL

Contents

Contents

1	Safety Precautions	5
1.1	General safety information.....	6
1.2	Commercial use only.....	6
1.3	Symbols.....	6
1.4	Additional notes.....	6
2	General	7
3	Display	8
4	Program description	9
5	Handling.....	10
5.1	Load	10
5.2	Detergent supply	10
5.3	The "Move back" key.....	11
5.4	To start the wash program	12
5.4.1	General	12
5.4.2	To start a wash program by entering the program number.....	14
5.4.3	To start a wash program from the program library.....	15
5.5	Delayed start.....	17
5.6	During program run.....	17
5.6.1	To change parameters in the current program step.....	17
5.7	Additional functions during the program	18
5.7.1	Rapid advance.....	19
5.7.2	Show weight (for machines with weighing equipment installed only).....	20
5.7.3	No water reduction (for machines with weighing equipment installed only).....	20
5.7.4	Manual functions.....	21
5.7.5	Pause.....	28
5.7.6	Text.....	29
5.7.7	Select new program.....	30
5.7.8	Auto restarts.....	31
5.7.9	Change °F / °C.....	32
6	Statistics.....	33
6.1	To select Statistics	33
6.2	Scale adjustments	36
6.2.1	Reset scale to zero.....	37
6.2.2	Reset tare to zero.....	38
6.2.3	Tare scale.....	39
6.2.4	Set tare to a certain value.....	40
6.2.5	Read tare value.....	41
6.2.6	Calibrate the scale.....	42
6.2.7	Zero calibration	45
6.2.8	Read version number	46
7	Memory Card.....	47
8	Maintenance	56
8.1	Daily	56
8.2	Every month.....	56
8.3	Calibration of level control system.....	57
8.4	Calibration of the scale (weight function).....	60
8.5	Calibration of the reference machines Wascator FOM 71 CLS.....	61
8.6	Door opening for test sample Wascator FOM71 CLS.....	64
9	Disposal information.....	65
9.1	Disposal of appliance at end of life	65
9.2	Disposal of packing.....	65

The manufacturer reserves the right to make changes to design and component specifications.

1 Safety Precautions

- Servicing shall be carried out only by authorized personnel.
- Only authorized spare parts, accessories and consumables shall be used.
- Only use detergent intended for water-wash of textiles. Never use dry cleaning agents.
- The machine shall be connected with new water hoses. Re-used water hoses must not be used.
- The machine's door lock must under no circumstances be bypassed.
- If the machine develops a fault, this must be reported to the person in charge as soon as possible. This is important both for your safety and that of others.
- DO NOT MODIFY THIS APPLIANCE.
- When performing service or replacing parts, the power must be disconnected.
- When the power is disconnected, the operator must see that the machine is disconnected (that the plug is removed and remains removed) from any point to which he has access. If this is not possible, due to the construction or installation of the machine, a disconnection with a locking system in the isolated position shall be provided.
- In accordance with the wiring rules: mount a multi-pole switch prior to the machine to facilitate installation and service operations.
- If different rated voltages or different rated frequencies (separated by a /) are stated at the machine data plate, instructions for adjusting the appliance for operation at the required rated voltage or rated frequency are stated in the installation manual.
- Stationary appliances not fitted with means for disconnection from the supply mains having a contact separation in all poles that provide full disconnection under overvoltage category III, the instructions state that means for disconnection must be incorporated in the fixed wiring in accordance with the wiring rules.
- The openings in the base, shall not be obstructed by a carpet.
- Maximum mass of dry cloth: 7 kg.
- A-weighted emission sound pressure level at working stations:
 - Wash: <70 dB(A).
 - Extraction: <70 dB(A).
- Maximum inlet water pressure: 1000 kPa
- Minimum inlet water pressure: 50 kPa
- Additional requirements for the following countries; AT, BE, BG, HR, CY, CZ, DK, EE, FI, FR, DE, GR, HU, IS, IE, IT, LV, LT, LU, MT, NL, NO, PL, PT, RO, SK, SI, ES, SE, CH, TR, UK:
 - CAUTION: This appliance shall not be installed where the public has access.
- Additional requirements for other countries:
 - This appliance is not intended for use by persons (including children) with reduced physical, sensory or mental capabilities, or lack of experience and knowledge, unless they have been given supervision or instruction concerning use of the appliance by a person responsible for their safety. Children should be supervised to ensure that they do not play with the appliance.
 - This appliance is intended to be used in household and similar applications such as: (IEC 60335-2-7) staff kitchen areas in shops, offices and other working environments, farm houses, by clients in hotels, motels and other residential type

environments, bed and breakfast type environments, areas for communal use in blocks of flats or in laundrettes.

1.1 General safety information

The machine is only intended for water-wash use.



Do not hose down the machine with water.

In order to prevent damage to the electronics (and other parts) that may occur as the result of condensation, the machine should be placed in room temperature for 24 hours before being used for the first time.

1.2 Commercial use only

The machine/machines covered by this manual is/are made for commercial and industrial use only.

1.3 Symbols

	Caution
	Caution, high voltage
	Read the instructions before using the machine

1.4 Additional notes

Note!

Weight calibration (only Wascator FOM71 CLS):

If the value in the display shows more than ± 0.1 kg, reset scale to zero.

Level calibration:

Check and calibrate if a longer test serie is to commence.

Note!

Some of the display texts and functions may not appear on your machine version.

2 General

This machine is controlled by a microprocessor-based program control unit. There are many advantages to this equipment, including:

- Timing, levels and temperatures are controlled with great precision and flexibility.
- Detailed information on wash programs, machine status and operations, wash times and temperatures can be accessed in plain language on the large display screen.
- It is possible for the user to create new wash programs and to adapt wash programs precisely on the basis of experience and to suit various types of textile, degrees of soiling, etc.
- A very high level of machine safety through continuous monitoring and built-in safety interlocks.
- The program control unit has a reader for "memory cards". These are cards the size of a credit card which contain a memory chip.

Memory cards allow the user to:

- Transfer wash programs between a PC and the machine, or from one machine to another.
- Run wash programs straight from a memory card.

Great flexibility during program operation:

- Rapid advance both forwards and backwards in the wash program.
- Change temperatures, program module lengths and extraction speeds directly, during program operation.
- Start a different wash program at any time during program operation.

3 Display

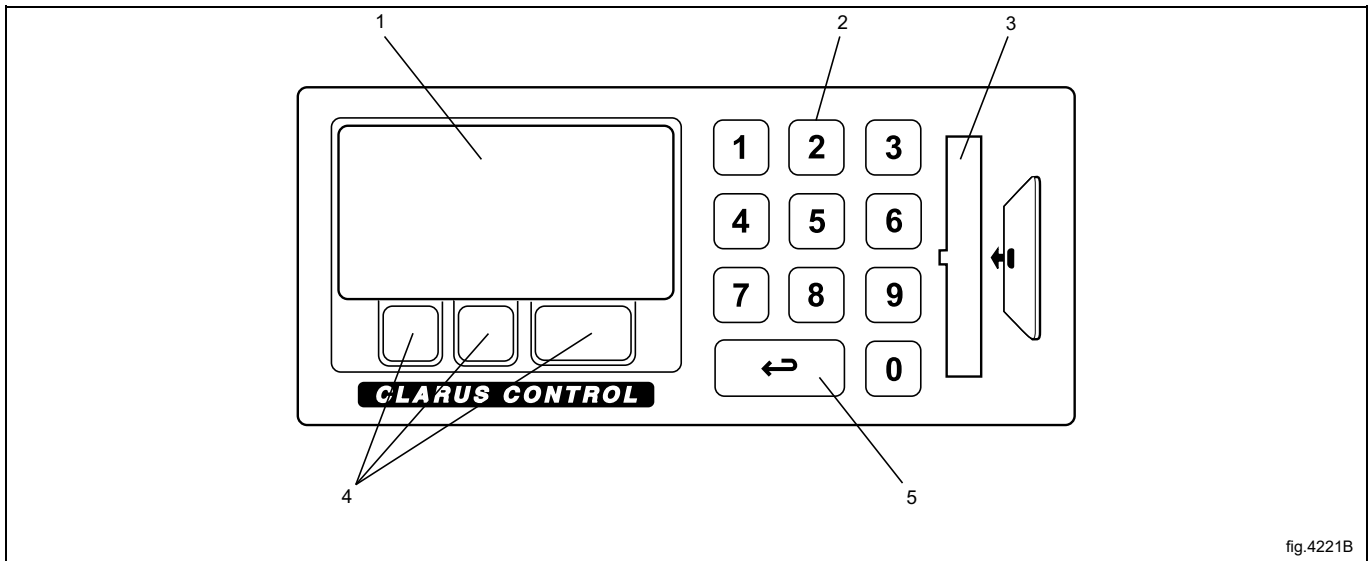

fig.4221B

1	Display screen
2	Numeric keyboard
3	Card reader for "memory cards"
4	The functions of these keys change, depending on which menu or part of a menu you are using. Their current functions at any time are shown on the display immediately above each key.
5	The "Move back" key By pressing this key repeatedly you can move backwards through the menus you have navigated through.

4 Program description

The machine's program control unit has nine standard wash programs in memory: 991–999.

The following table shows the standard wash programs and a short description of those:

Wash program		Description
991	Start-up program	If the machine has been idle more than two hours, this program should be run before any other program is run.
992	Level check	Check with the ruler inside the drum. Program fills machine with water to a reference level at 160 mm, maintains this level 20 seconds and goes into a pause state with alarm. Press PAUSE and the machine will be emptied. This process is repeated five times. After that, the program fills machine with water to the following levels one after the other: 100 mm, 130 mm, 160 mm and 200 mm. Each level is maintained 40 seconds before emptying.
993	Weight check	Program fills the machine with water to 18 kg, wait 30 seconds, rotates 60 seconds and fills to 26 kg (+8) and waits 30 seconds. Then drain.
994	Temperature check	Program fills machine with water to 130 mm level and warms it in five steps: 25°C for 2 minutes, 40°C for 2 minutes, 60°C for 2 minutes, 80°C for 2 minutes and 90°C for 2 minutes. The machine is emptied, filled twice with cold water to a high level 200 mm and finishes with a two minute spin cycle 1000 rpm. The buzzer sounds at the end of the program.
995	Low extraction 500 rpm 1 minute.	
996	Low extraction 500 rpm 5 minutes.	
997	Extraction 775 rpm 2 minutes (15s 550)	
998	Extraction 950 rpm 4 minutes (15s 550 + 15s 775)	
999	High extraction 1100 rpm 5 minutes (15+15+20s 950)	

5 Handling

5.1 Load

- Sort the load, paying attention to the textile care labels on the items. Empty all pockets and do up zip fasteners.
- Open the machine door, check that the drum is empty, load the items into the machine and close the door.

5.2 Detergent supply

If the machine is not connected to an automatic liquid chemical injection system; add the correct amount of detergent and softener according to recommendations.

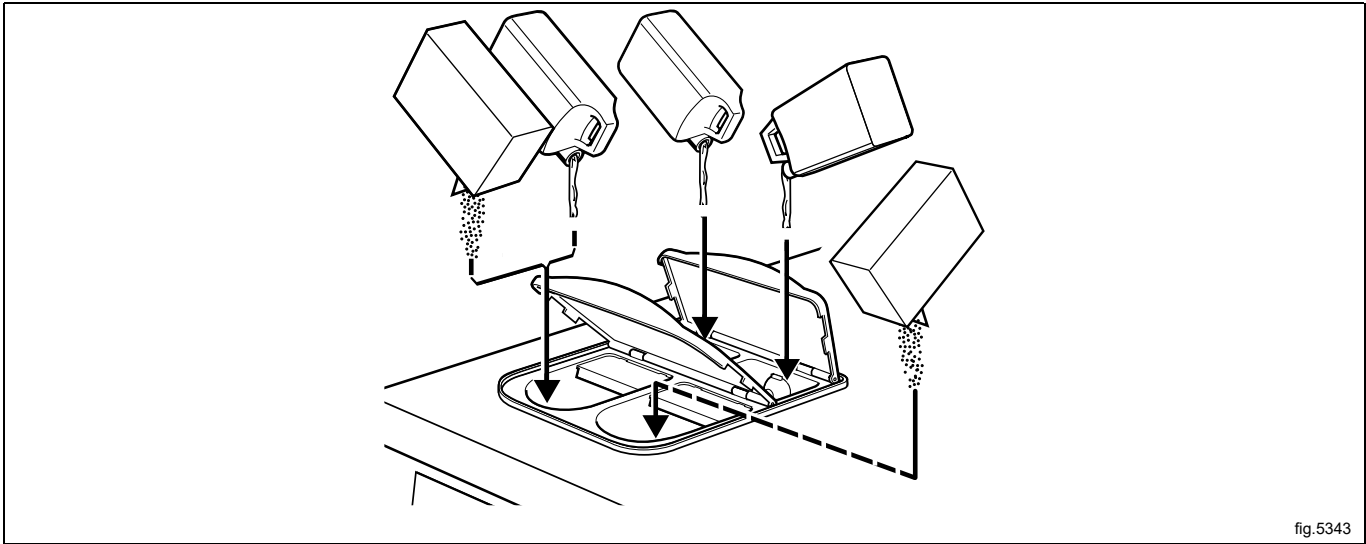

fig.5343

Compartment 1 – pre wash, powder or liquid detergent

Compartment 2 – main wash, powder detergent

Compartment 3 – softener

Note!

When using weight control softener can not be used (compartment 3 will be used for dosing water in all baths).

Compartment 4 – main wash, liquid detergent.

5.3 The "Move back" key

Each press of the "Move back" key moves you back one menu, in reverse order. By pressing this key repeatedly you can return to this menu at any time:

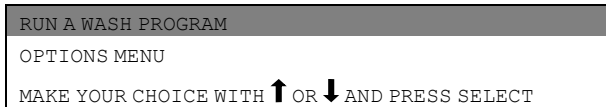

If you find you are in the wrong place, or if you want to undo earlier key presses:

Press the "Move back" key  one or more times.

5.4 To start the wash program

5.4.1 General

There are two ways to start a wash program:

1. By entering the actual program number
2. By starting from the program library

If you are unsure about the programs available, you can select a program from the program library, where the programs are listed with their descriptions.

Press **↓** or **↑** one or more times to highlight RUN A WASH PROGRAM.

Press **SELECT**.

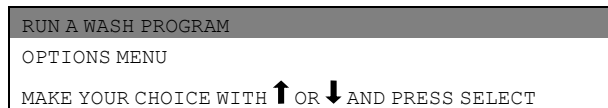

Here you can select programs from the program libraries (A). See the section entitled "To start a wash program from the program library".

Displayed here will be the number of the most frequently used program (B).

Press this key if you want to select this program (C).

Use the numeric keys to enter the program number.

If you have entered the wrong number, enter the correct number to overstrike the earlier one.

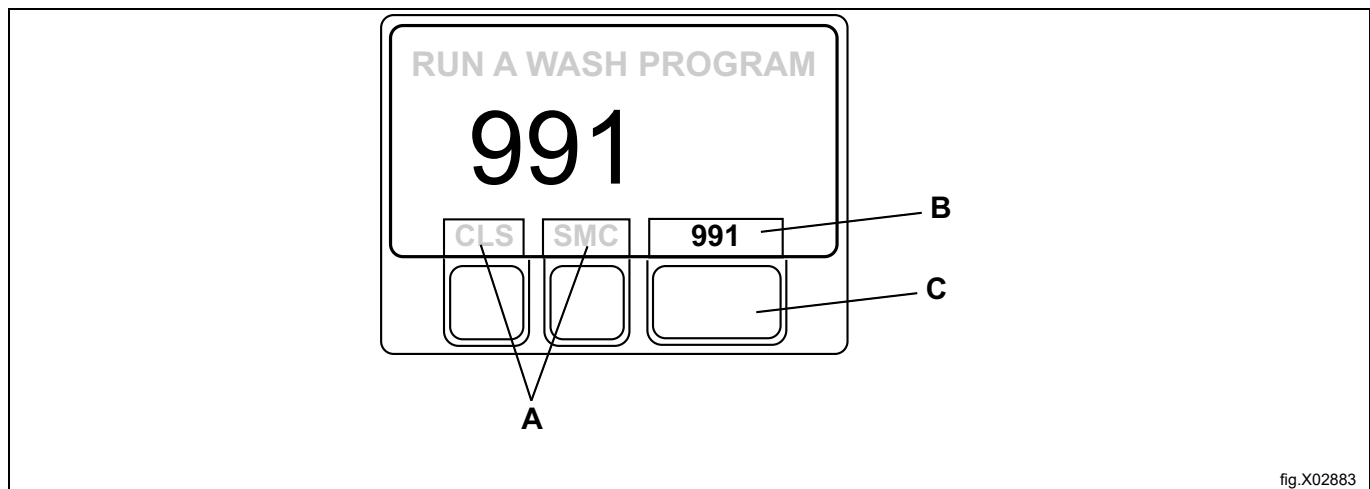

fig.X02883

Press **SELECT**.

The following information is displayed during the wash program:

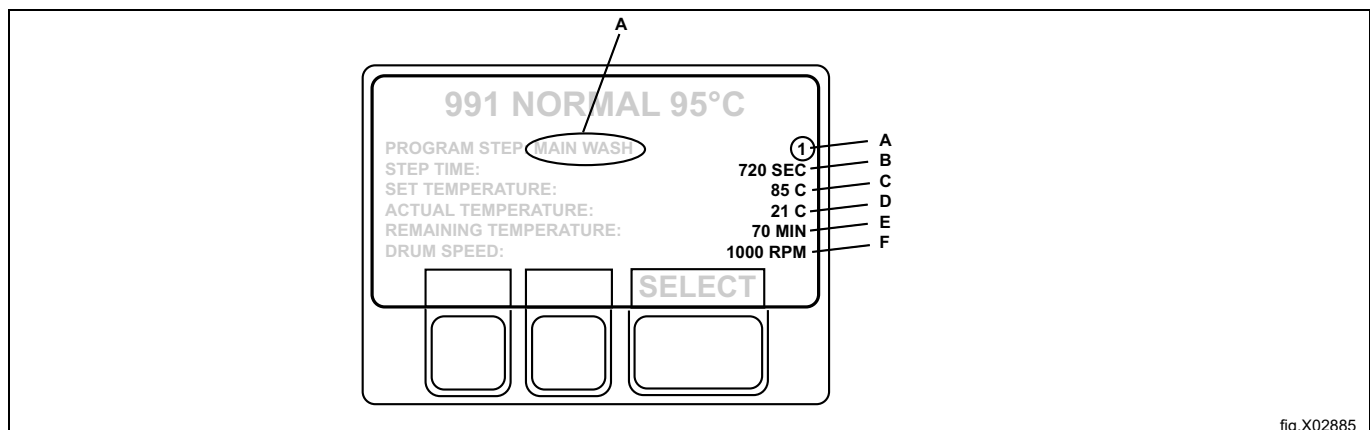

fig.X02885

A	Current program step
B	Time left for this program step
C	Set temperature
D	Actual temperature
E	Remaining program time
F	Drum speed

If you have a memory card in the program control unit (PCU), and the program you selected is both on the memory card and in the PCU, you will be asked "FROM CLS OR SMC?".

- Press CLS if you want to take the program from the PCU.
- Press SMC if you want to take the program from the memory card.

In some of the text shown on the display, Clarus Control is referred to as CLS and the memory card is referred to as SMC.

5.4.2 To start a wash program by entering the program number

Use the numeric keyboard to enter the wash program number and press **SELECT**.

1	MY OWN 40 °C
2	MY OWN 60°C
3	MY OWN 90°C
991	Start-up program
992	Level check
993	Weight check
994	Temperature check
995	Low extraction 500 rpm 1 minute
996	Low extraction 500 rpm 5 minutes
997	Extraction 775 rpm 2 minutes (15s 550)
998	Extraction 950 rpm 4 minutes (15s 550 + 15s 775)
999	High extraction 1100 rpm 5 minutes (15 + 15 + 20s 950)

If you have entered the wrong number

Enter the correct number to overstrike the earlier one.

For example: 991.

Use the numeric keys to enter the program number.

Press **SELECT**.

5.4.3 To start a wash program from the program library

The program library lists all wash programs, both user and standard programs, showing their program numbers and a description.

Each time a new program is stored in the machine program memory, its number and description will be inserted automatically into the program library.

The program library may be used for starting a wash program, but is also used in programming, when a wash program needs to be modified or if a new program is to be created on the basis of an existing one.

If you have a memory card in the program control unit, and the program you selected is both on the memory card and in the PCU, you will be asked "FROM CLS OR SMC?".

Press CLS if you want to take the program from the PCU.

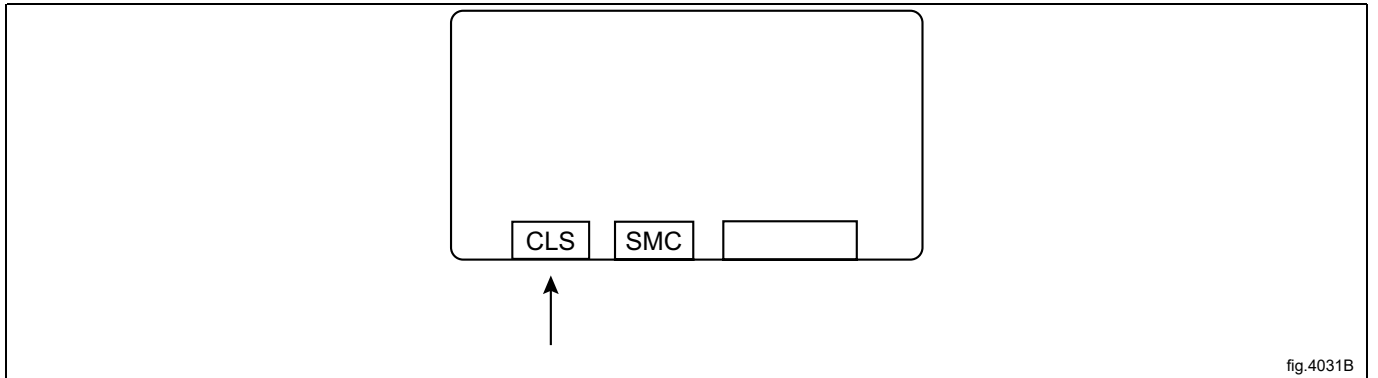

fig.4031B

Press SMC if you want to take the program from the memory card.

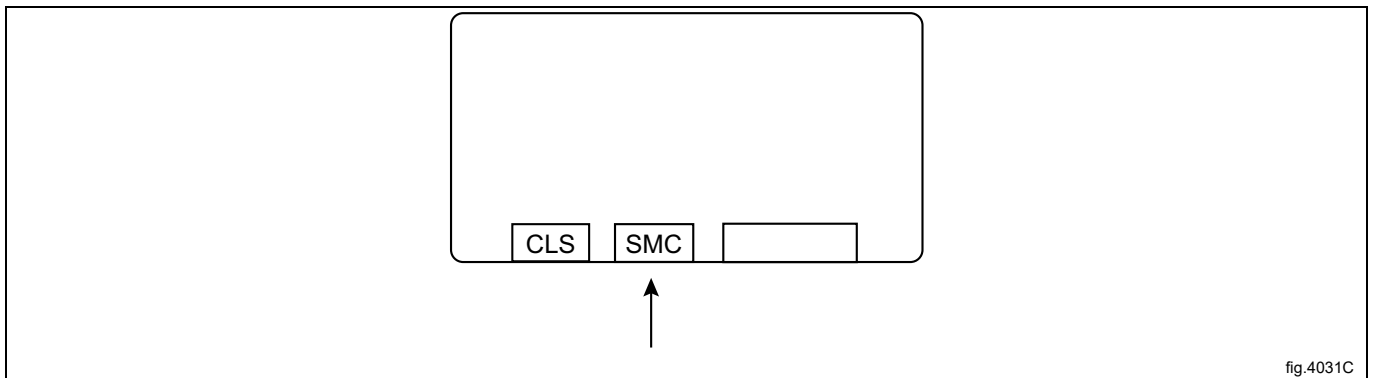
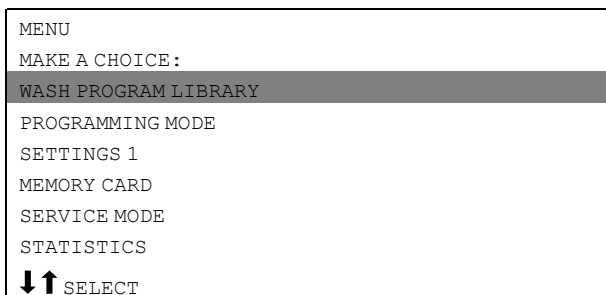

fig.4031C

You can also select the program library via the option "OPTIONS MENU". Then select "WASH PROGRAM LIBRARY".



Press **↓** the required number of times to highlight the wash program required.

991 Start-up program
992 Level check
993 Weight check
994 Temperature check
995 Low extraction 500 rpm 1 minute
996 Low extraction 500 rpm 5 minutes
997 Extraction 775 rpm 2 minutes (15s 550)
998 Extraction 950 rpm 4 minutes (15s 550 + 15s 775)
999 High extraction 1100 rpm 5 minutes (15 + 15 + 20s 950)

Press **SELECT**.

Memory cards

A memory card is a plastic card, the size of a credit card, with an electronic memory chip inside it. This card is capable of storing 10 to 15 wash programs of normal size. If the programs are mostly small ones, more of them can be stored, whereas larger programs will reduce the number which can be held by the card. Memory cards of this type can be used to:

- transfer wash programs from one machine to another
- run wash programs straight from the card
- transfer wash programs from a PC to a memory card and from a memory card to a PC.

5.5 Delayed start

Delayed start means that the machine will not start the wash program until the time entered has elapsed. This function allows you, for example, to load the machine in the evening, but delay the start of the wash until early the next morning, to end in time for the next shift.

Use the numeric keys to enter a time (max. 99 hrs). This parameter appears on the right of the display.

Press **START** to save the set time (the time will start counting down immediately).

If the display shows for example 12.00 the wash program will start after 12 hours.

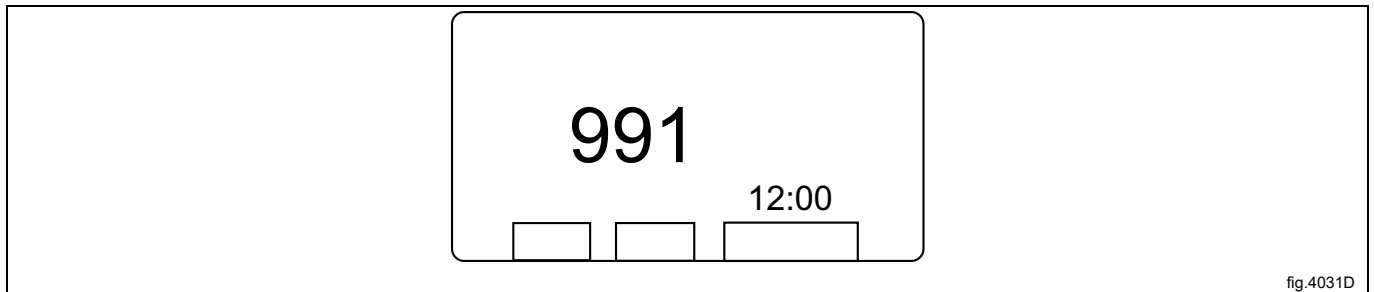

fig.4031D

If you want to cancel the delayed start:

Press **EXIT**.

5.6 During program run

5.6.1 To change parameters in the current program step

You can alter the following program steps:

- **Prewash, Main wash, Rinse, Drain, Soak**
Length of program step (max. 9998 seconds), heating temperature (max. 97°C).
- **Extraction**
Length of program step (max. 3599 seconds), extraction speed.

Press **↑** one or more times to highlight the line required.

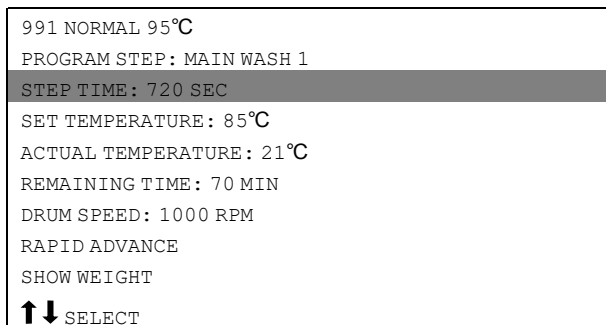

Press **SELECT**

If you have entered the wrong parameter

Continue pressing numeric keys to overstrike the incorrect parameter.

Note!

Always use the same number of digits as used on the display to overstrike the incorrect parameter.

Example:

To change the time for the program step to 30 seconds, enter 030 to overstrike the earlier parameter.

Use the numeric keys to enter the new parameter.

Press **SELECT**.

5.7 Additional functions during the program

RAPID ADVANCE	Rapid advance through the program to the program step required. Rapid advance can be used to move both forwards and backwards through the program.
SHOW WEIGHT	The actual load weight is shown in large digits on the display (weight display mode). (On machines with weighing equipment only.)
NO WATER REDUCTION	Machines with weighing equipment installed adjust the water level automatically according to the load weight. This function lets you switch off water level reduction during the current program.
MANUAL FUNCTIONS	The following functions can be controlled manually during the course of the program: <ul style="list-style-type: none"> • all water valves, drain and pumps (where applicable). • limit highest extraction speed. • motor on/off after end of wash program. • flush detergent.
PAUSE	The machine stops. The drain valve remains closed. Another way to pause the program: Press  .
TEXT	Display description of wash program (if available).
SELECT NEW WASH PROGRAM	You can switch to using a different wash program at any stage during the wash. Once this function has been selected, the current step (for example, rinse) of the earlier program will be allowed to finish and then the new program will start (from the beginning).
AUTO RESTARTS	Here you enter the number of times you wish the wash program to restart automatically.
CHANGE °F/°C	This function changes the temperature scale used for all temperatures displayed during the wash.

5.7.1 Rapid advance

To terminate a program before it has finished:

- Select RAPID ADVANCE and press SELECT. Advance to "END OF PROGRAM" and press SELECT.
- Wait until "THE DOOR IS UNLOCKED" appears on the display.
- Now the door can be opened.

```

991 NORMAL 95°C
PROGRAM STEP: MAIN WASH 1
STEP TIME: 720 SEC
SET TEMPERATURE: 85°C
ACTUAL TEMPERATURE: 21°C
REMAINING TIME: 70 MIN
DRUM SPEED: 1000 RPM
RAPID ADVANCE
SHOW WEIGHT
↑↓ SELECT

```

Check that RAPID ADVANCE is highlighted.

```

RAPID ADVANCE
SHOW WEIGHT
SHOW WEIGHT
NO WATER REDUCTION
MANUAL FUNCTIONS
PAUSE
TEXT
SELECT NEW WASH PROGRAM
AUTO RESTARTS
CHANGE °F/°C

```

If it is not highlighted:

Press ↓ or ↑ one or more times to highlight RAPID ADVANCE.

Press SELECT.

Rapid advance works in both directions, using ↓ and ↑.

Using rapid advance to move forwards allows you to skip one or more program steps. Using rapid advance backwards allows you to repeat one or more program steps.

Press ↓ or ↑ one or more times to highlight the program step you wish to advance to.

Press SELECT.

```

MAIN WASH 1
DRAIN 1
RINSE 1
DRAIN 2
EXTRACT 1
RINSE 2
DRAIN 3
EXTRACT 2
RINSE 3
DRAIN 4
EXTRACT 3
END OF PROGRAM

```

Automatic return to normal display

If no keys are pressed within 20 seconds, the display will revert automatically to its previous appearance.

5.7.2 Show weight (for machines with weighing equipment installed only)

The actual weight is shown in large digits on the display (weight display mode).

If the weighing equipment is not connected, the error message "FUNCTION NOT ALLOWED" will appear.

Press ↓ or ↑ one or more times to highlight "SHOW WEIGHT".

Press SELECT.

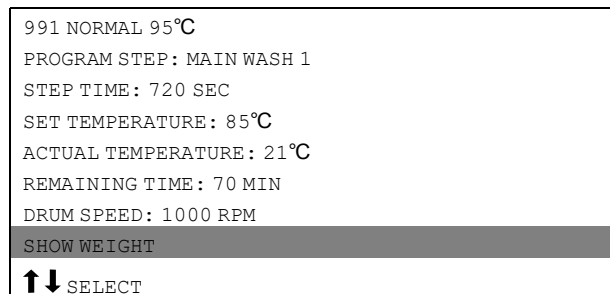

The actual net weight is shown in large digits on the display.

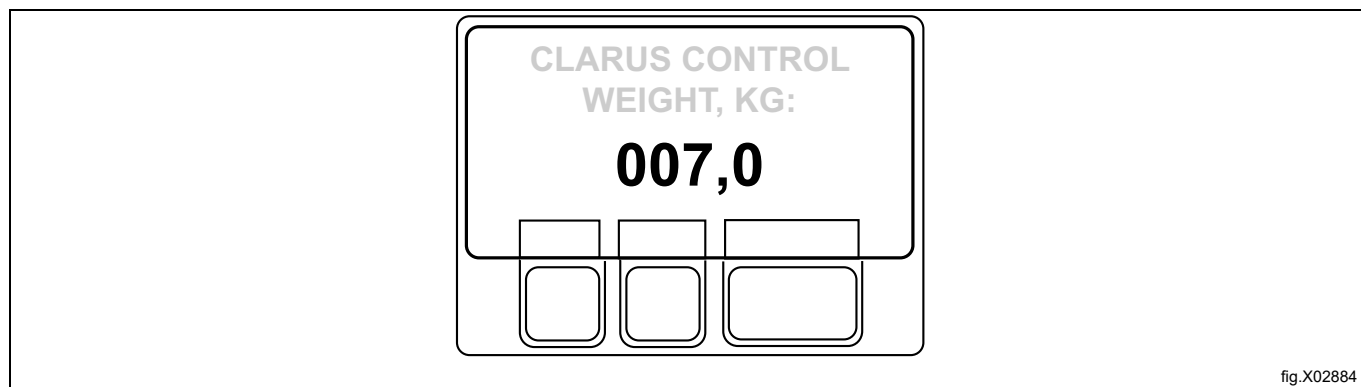

5.7.3 No water reduction (for machines with weighing equipment installed only)

Note!

This function is not valid for this machine. When selecting this function the text "NOT ALLOWED FUNCTION" will be shown on the display.

The wash load is weighed during the program and the water level is adjusted automatically according to its weight. If the load is not a full one, the water level will be reduced according to a water level reduction table. You can switch off water level reduction at any stage of a program.

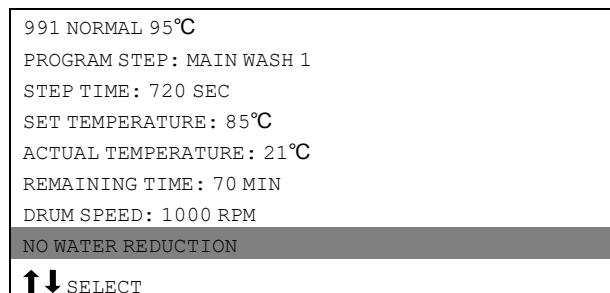

5.7.4 Manual functions

There are two types of manual operation:

- Manual operation during a program.
- Manual operation when no program is running.

5.7.4.1 Manual operation during a program

Press **↓** or **↑** one or more times to highlight MANUAL FUNCTIONS.

991 NORMAL 95°C
PROGRAM STEP: MAIN WASH 1
STEP TIME: 720 SEC
SET TEMPERATURE: 85°C
ACTUAL TEMPERATURE: 21°C
REMAINING TIME: 70 MIN
DRUM SPEED: 1000 RPM
MANUAL FUNCTIONS
↑↓ SELECT

Use the cursor keys to select the function.

991 NORMAL 95°C
MAKE A CHOICE
WATER/DRAIN
HIGH EXTRACT
MOTOR
DETERGENT/FLUSH
EXIT

Manual functions during a program

WATER/DRAIN	Allows manual operation of all water valves and the drain valve.
HIGH EXTRACT	Here you can limit the maximum extraction speed for the current program.
MOTOR	Motor on/off after program has ended.
DETERGENT/FLUSH	Allows you to control all valves in the detergent compartment or in external detergent supply.

Use the cursor keys to select the function.

Press **SELECT**.

Water/drain

Note!

For this function, all of the menus will not be available on machines with one I/O board.

Use ↓ and ↑ to select the water/drain option you require.

WATER/DRAIN
COLD WATER
MIXED WATER
HOT WATER
COLD HARD WATER
WATER FROM TANK 1
WATER FROM TANK 2

Press Y/N.

With Y (Yes) the function is activated and with N (No) the function is not activated.

When you have finished: Press ↓ repeatedly to highlight EXIT.

COLD WATER
MIXED WATER
HOT WATER
COLD HARD WATER
WATER FROM TANK 1
WATER FROM TANK 2
WATER FROM TANK 2
DRAIN
EXIT

Press SELECT.

High extract

This function makes it possible to change the maximum extraction speed.

Select the menu HIGH EXTRACT.

Enter the maximum extraction speed required for the ongoing wash program.

Example: Assume that the highest speed in the program is 1000 rpm and that you have set 700 rpm as the highest speed allowed.

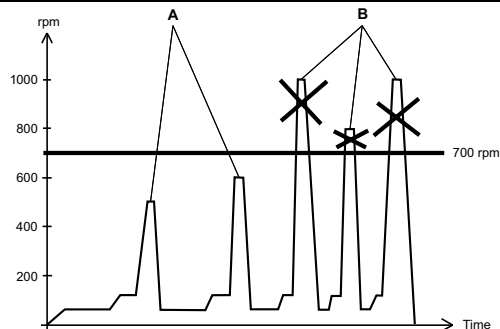

fig.3682B

A	Speeds below 700 rpm will not be affected
B	All speeds above 700 rpm will be limited to 700 rpm

This change will affect the current program only. No change will be implemented if extraction is taking place at the time of the (attempted) change. The next time that this program is used, the original maximum speed will apply.

This function does not allow you to set a higher speed than the usual maximum speed for the program.

Motor

This function allows the motor to rotate after program has ended.

Select the menu MOTOR.

Use Y/N to toggle the function from ON (Yes) to OFF (No).

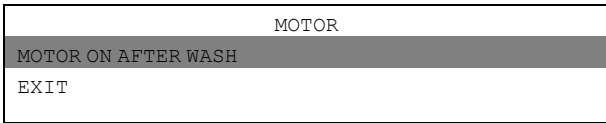

If you answer Yes (Y):

The motor will continue to rotate in alternative directions after the program has ended. This prevents creasing of the load.

When the program has ended, the display will look like this:

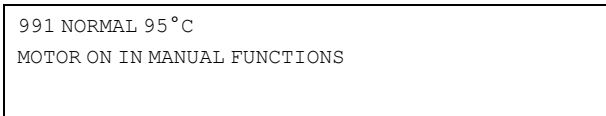

Press STOP to stop the motor.

When you have finished:

Press ↓ to highlight "EXIT".



Press SELECT.

Detergent/flush

Note!

For this function, all of the menus will not be available on machines with one I/O board.

Use ↓ and ↑ to select the function you require.

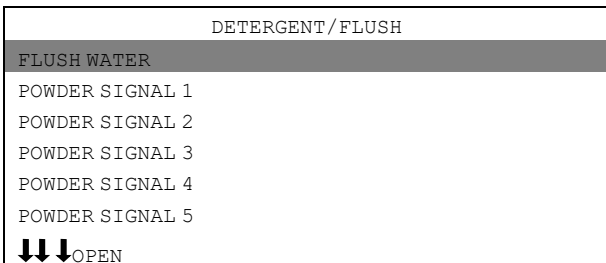

Detergent signals and water flushing:

- **FLUSH WATER:**

This function uses water to clear detergent from the supply tubes of the detergent dispensing system.

- **POWDER SIGNAL:**

This function will either: a) use water to dispense detergent from machine compartments, or: b) dispense detergent from an external system. The number of valves present will vary according to the machine type.

Press OPEN.

The function will be activated for as long as you press and hold this key. The function ceases as soon as you release the key.

FLUSH WATER
POWDER SIGNAL 1
POWDER SIGNAL 2
POWDER SIGNAL 3
POWDER SIGNAL 4
POWDER SIGNAL 5
LIQUID SIGNAL 1
LIQUID SIGNAL 2
LIQUID SIGNAL 3
LIQUID SIGNAL 4
LIQUID SIGNAL 5
LIQUID SIGNAL 6
LIQUID SIGNAL 7
LIQUID SIGNAL 8
EXIT

When you have finished:

Press **↓** repeatedly to highlight "EXIT".

Press SELECT.

5.7.4.2 Manual operation when no program is running

You must always close and lock the door first before you can operate the machine manually.

To lock the door, use the submenu MOTOR/DOOR.

Press **↓** to highlight "OPTIONS MENU".

Press SELECT.

RUN A WASH PROGRAM
OPTIONS MENU

Press **↓** to highlight "MANUAL MODE".

Press SELECT.

WASH PROGRAM LIBRARY
PROGRAMMING MODE
SETTINGS 1
MEMORY CARD
SERVICE MODE
STATISTICS
MANUAL MODE
SETTINGS 1
EXIT

Use the cursor keys to select the function.

Press SELECT.

MOTOR/DOOR	Lock/unlock door. Switch motor on/off (normal drum action).
WATER/DRAIN	Operation of drain valve and all water valves.
HEATING	Heat water to any temperature required.
DETERGENT/FLUSH	Allows manual operation of all valves in detergent compartment or external detergent supply system.

All manual settings (such as door, motor, temperature, and drain) will be cancelled when you exit manual operation. The door is unlocked, the motor stops, the drain opens, heating is halted, and the temperature is reset to zero.

Motor/Door

Those functions will lock the door and start the motor.

Use Y/N to toggle the function from ON (Yes) to OFF (No).

DOOR LOCK ON

If you answer **Yes (Y)**:

- The door will be locked. Note that you must always lock the door before you can operate the machine manually.

MOTOR ON

If you answer **Yes (Y)**:

- The motor will start and operate, using normal action.

Press **↓** as required to select a function.

MANUAL MODE
MOTOR DOOR
DOOR LOCK ON
MOTOR ON
EXIT

When you have finished:

Press **↓** to highlight "EXIT".

Press SELECT.

Water/drain

Note!

For this function, all of the menus will not be available on machines with one I/O board.

Use **↓↑** to select Drain or one of the six Water filling alternatives.

DRAIN CLOSED
COLD WATER
MIXED WATER
HOT WATER
HARD WATER
WATER FROM TANK 1
WATER FROM TANK 2
WATER FROM TANK 3
EXIT

Drain:

- Use Y/N to toggle the function from ON (Yes) to OFF (No).

Water filling:

- Press OPEN.
- The function will be activated for as long as you press and hold this key. The function ceases as soon as you release the key.

When you have finished:

Press **↓** to highlight "EXIT".

Press SELECT.

Heating

Use the numeric keys to enter the temperature the water is to be heated to.

Press START.

Heating will now begin.

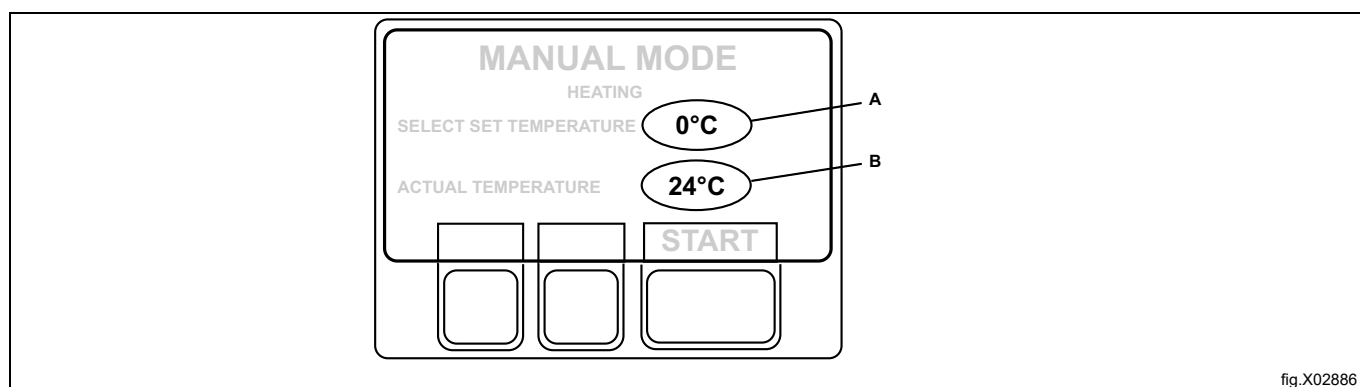

fig.X02886

A	Temperature selected
B	Actual temperature

If you wish, you can cancel heating before the set temperature is reached:

Access the function again and press STOP.

Detergent/flush**Note!**

For this function, all of the menus will not be available on machines with one I/O board.

Use ↓↑ to select the function you require.

MANUAL MODE
DETERGENT/FLUSH
FLUSH WATER
POWDER SIGNAL 1
POWDER SIGNAL 2
POWDER SIGNAL 3
POWDER SIGNAL 4
POWDER SIGNAL 5

Detergent signals and water flushing**FLUSH WATER:**

This function uses water to clear detergent from the supply tubes of the detergent dispensing system.

POWDER SIGNAL:

This function will either:

1. use water to dispense
or
2. dispense detergent from an external system.

The number of valves present will vary according to the machine type.

FLUSH WATER
POWDER SIGNAL 1
POWDER SIGNAL 2
POWDER SIGNAL 3
POWDER SIGNAL 4
POWDER SIGNAL 5
LIQUID SIGNAL 1
LIQUID SIGNAL 2
LIQUID SIGNAL 3
LIQUID SIGNAL 4
LIQUID SIGNAL 5
LIQUID SIGNAL 6
LIQUID SIGNAL 7
LIQUID SIGNAL 8
EXIT

Press OPEN.

The function will be activated for as long as you press and hold this key. The function ceases as soon as you release the key.

When you have finished:

Press ↓ repeatedly to highlight "EXIT".

Press SELECT.

5.7.5 Pause

Note!

You must be in normal wash mode to be able to pause in this way. If, for example, you are using "Manual Functions", you will have to exit that first before you can use Pause.

There are two ways of pausing during a program:

1. By pressing .
2. As an additional function.

Press **↓** or **↑** one or more times to highlight "PAUSE".

Press SELECT.

991 NORMAL 95°C
PROGRAM STEP: MAIN WASH 1
STEP TIME: 720 SEC
SET TEMPERATURE: 85°C
ACTUAL TEMPERATURE: 21°C
REMAINING TIME: 70 MIN
DRUM SPEED: 1000 RPM
PAUSE

When the machine pauses:

- Program operation is halted.
- Filling is halted (where applicable).
- Heating is halted (where applicable).
- The motor stops.
- The drain valve remains closed.
- The door cannot be opened.

Press START to restart the wash program.

5.7.6 Text

Pressing **TEXT** displays more information.

The text displayed is a description of the program selected. This text description is inserted when a new program is created. This procedure is described fully in the programming manual.

Choose 1 or 2:

1. To start the program now:

Press **START**.

2. Delayed start:

Use the numeric keys to enter a time (max. 99 hrs). This parameter appears on the right of the display.

Press **↓** or **↑** one or more times to highlight "TEXT".

Press **SELECT**.

991 NORMAL 95°C
PROGRAM STEP: MAIN WASH 1
STEP TIME: 720 SEC
SET TEMPERATURE: 85°C
ACTUAL TEMPERATURE: 21°C
REMAINING TIME: 70 MIN
DRUM SPEED: 1000 RPM
TEXT
↑↓SELECT

Description of selected wash program:

991 NORMAL 95°C
NORMAL PROGRAM FOR MEDIUM SOILED CLOTHES

To return to the normal display:

Press **SELECT** again.

5.7.7 Select new program

You can change to a different program at any time during program operation. When you do, the current function (for example, rinse) will be interrupted. The new program will start immediately after that (from the beginning).

This function is useful, for example, if you discover that you have started the wrong program.

Press **↓** or **↑** one or more times to highlight "SELECT NEW WASH PROGRAM".

Press SELECT.

```

991 NORMAL 95°C
PROGRAM STEP: MAIN WASH 1
STEP TIME: 720 SEC
SET TEMPERATURE: 85°C
ACTUAL TEMPERATURE: 21°C
REMAINING TIME: 70 MIN
DRUM SPEED: 1000 RPM
SELECT NEW WASH PROGRAM
↑↓SELECT

```

Press **↓** one or more times as required to highlight the new wash program.

Press SELECT.

The existing program will now be interrupted and the new one will begin.

```

991 Start-up program
992 Level check
993 Weight check
994 Temperature check
995 Low extraction 500 rpm, 1 min.
997 Extraction 775 rpm 2 minutes (15s 550)
998 Extraction 950 rpm 4 minutes (15s 550 + 15s
775)
999 High extraction 1100 rpm 5 minutes (15 + 15 +
20s 950)

```

5.7.8 Auto restarts

Auto restart means that the same program will be repeated one or more times, according to the number set. The program will restart immediately and the door will remain locked. If you have set auto restart, the display will show the number of restarts left.

This function is used primarily for testing.

Press **↓** or **↑** one or more times to highlight "AUTO RESTARTS".

Press SELECT.

991 NORMAL 95°C
PROGRAM STEP: MAIN WASH 1
STEP TIME: 720 SEC
SET TEMPERATURE: 85°C
ACTUAL TEMPERATURE: 21°C
REMAINING TIME: 70 MIN
DRUM SPEED: 1000 RPM
AUTO RESTARTS
↑↓SELECT

Use the numeric keys to change the required number of restarts. The below example shows 1 restart of the program.

Press SELECT.

991 NORMAL 95°C
AUTO RESTARTS? 1

5.7.9 Change °F / °C

This function changes the temperature scale used for all temperatures displayed during the program.

Please note that this scale change applies only to the current program. The default temperature scale will apply next time you run a program.

Press **↑** or **↓** one or more times to highlight "CHANGE °F/°C".

Press **SELECT**.

991 NORMAL 95°C
PROGRAM STEP: MAIN WASH 1
STEP TIME: 720 SEC
SET TEMPERATURE: 85 C
ACTUAL TEMPERATURE: 21 C
REMAINING TIME: 70 MIN
DRUM SPEED: 1000 RPM
CHANGE °F/°C
↑↓
SELECT

6 Statistics

6.1 To select Statistics

If this menu is not currently displayed:

Press  repeatedly.

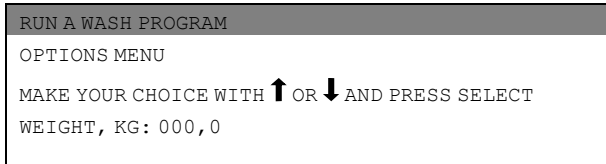

Press  to highlight "OPTIONS MENU".

Press SELECT.



Press  until "STATISTICS" is highlighted.

Press SELECT.

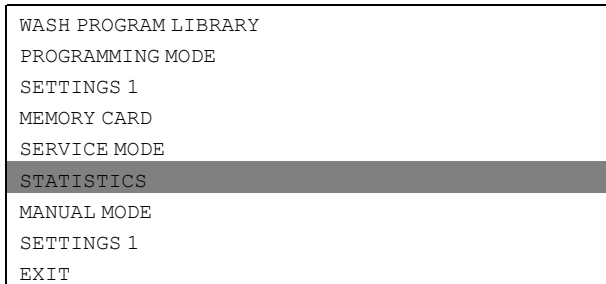

The Statistics function gives you access to the following information:

TOTAL RUN TIME HOURS	Shows the total operating time for the machine since it was installed.
TOTAL TRIP RUN TIME HOURS	This register records the total number of operating hours since it was last reset. It can, for example, be used to keep track of operating time since the last machine service. The procedure for resetting it is described in section "To reset "Total trip run time hours" to zero".
HOURS SINCE LAST SERVICE	This register shows the time elapsed since the last service. The register can also be used to generate a signal on the display to show when service is needed (see the section "Settings 1" in the service manual).
LAST 5 ERROR CODES	This displays the most recent error codes, and tells which program was operating at the time and during which hour (according to the "total run time" record) the error code was flagged.
NO. OF TIMES EACH PROGRAM USED	Displays statistics for PCU programs and for programs on any memory card currently in place in the PCU.

To display the next page of statistics:

Press .

If a memory card is in place in the PCU, the memory card program statistics will be displayed. An "S" before the program number shows that it is a memory card program.

When you want to cancel the display of statistics:

Press EXIT.

Resetting statistic registers

The following registers in the statistics function can be cleared (reset to zero):

- Total trip run time hours.
- Hours since last service.
- No. of times each program used (PCU programs).
- No. of times each program used (programs on any memory card currently in the PCU).

If this menu is not currently displayed:

Press  repeatedly.

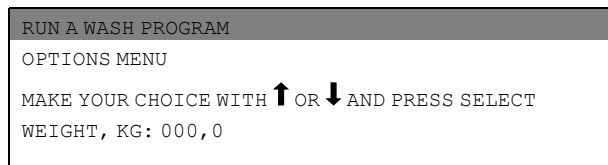

Press  to highlight "OPTIONS MENU".

Press SELECT.



Press  until "SERVICE MODE" is highlighted.

Press SELECT.

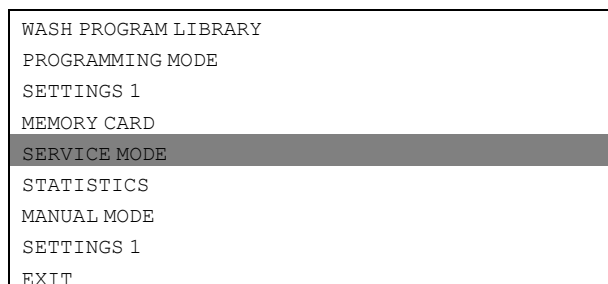

Note!

The service program may only be used by authorised personnel, because most safety interlocks are disabled.

Now you can choose either to clear/reset a register or to adjust the weighing equipment.

Press  to highlight the option you want, then press SELECT.

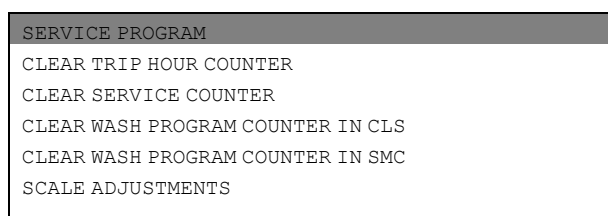

If you want to exit:

Press  until EXIT is highlighted.

Press SELECT.

Time counter, hours after last service

Both counters can be reset in the same way.

Press **↓** until CLEAR TRIP HOUR COUNTER or CLEAR SERVICE COUNTER is highlighted.

Press SELECT.

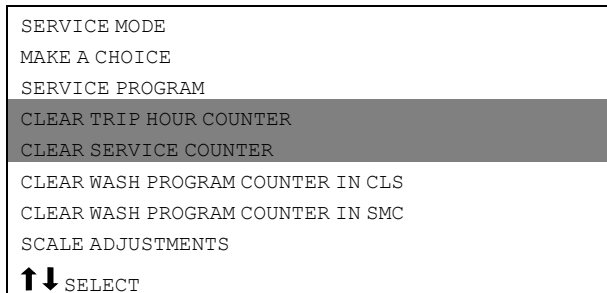

First you have a chance to change your mind.

If you **do not want to reset** the register: Press **any key other than** SELECT.

If you want to reset the register: Press **SELECT**.

Number of washes for program in timer or memory card

You can reset program in both timer and the memory card (if inserted).

Press **↓** until CLEAR WASH PROGRAM COUNTER IN CLS or CLEAR WASH PROGRAM COUNTER IN SMC is highlighted.

Press SELECT.

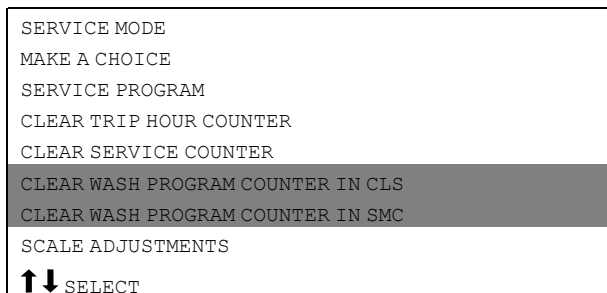

Write from which program number you want to clear wash programs.

Press **↓**.

Enter digits corresponding to the program number (inclusive) up to which you wish to clear the total counter.

Press ERASE.

First you have a chance to change your mind.

If you **do not want to reset** the register: **Press any key other than** SELECT.

If you want to reset the register: Press **SELECT**.

6.2 Scale adjustments

For machines with weighing equipment installed only!

Press **↓** until **SCALE ADJUSTMENTS** is highlighted.

Press **SELECT**.

SERVICE PROGRAM
MAKE A CHOICE
SERVICE PROGRAM
CLEAR COUNTER
CLEAR SERVICE COUNTER
CLEAR WASH COUNTER IN CLS
CLEAR WASH COUNTER IN MEMORY CARD
SCALE ADJUSTMENTS
↑↓ SELECT

When you have finished:

Press **↓** until **EXIT** is highlighted.

Press **SELECT**.

The following functions are accessed via the **SCALE ADJUSTMENTS** menu:

RESET SCALE TO ZERO	Used to make the weighing equipment display 0 when the machine has no load in it.
RESET TARE TO ZERO	Used to clear a stored tare parameter.
TARE SCALE	Used to reset the weighing equipment so that a weight such as a container will not be included when calculating net weight.
SET TARE TO A CERTAIN VALUE	Used to enter a value for the tare parameter, a weight in hectograms.
READ TARE VALUE	Used to check the value currently stored as the tare parameter.
CALIBRATE THE SCALE	This function is used only on installation of a new scale unit
ZERO CALIBRATION	Used to increase the accuracy of the weighing equipment
READ VERSION NUMBER	This is where you find the version number of the weighing equipment

If the weighing equipment is not connected, the error message "WEIGHING EQUIPMENT NOT CONNECTED" will be displayed. Connect the weighing equipment and try again.

6.2.1 Reset scale to zero

For machines with weighing equipment installed only!

"Reset weighing equipment" is used to make the weighing equipment display 0 when the machine has no load in it. If your attempt to reset the weighing equipment fails at this point, you will see an error message equivalent to: "FAILED. PRESS SELECT" on the display.

Check that "RESET SCALE TO ZERO" is highlighted.

If it isn't:

Press ↓ or ↑ as required to highlight "RESET SCALE TO ZERO".

Press SELECT.

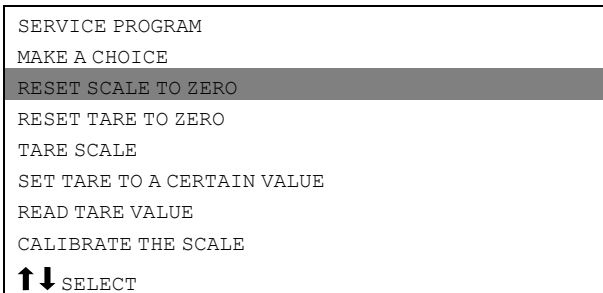

Note!

The machine must be unladen when you use this function, i.e. no water or wash load in the drum.

Note!

After a power-cut, the weighing equipment will always display 0, no matter what the actual load in the drum. In this event you will have to use the "Reset scale to zero" function.

This screen shows that the weighing equipment has been reset to zero.

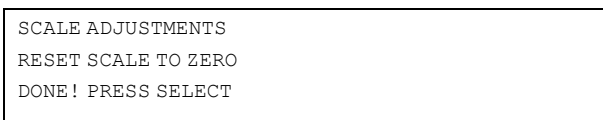

Press SELECT.

6.2.2 Reset tare to zero

For machines with weighing equipment installed only!

If your attempt to clear the tare parameter fails at this point, you will see an error message equivalent to: "FAILED. PRESS SELECT" on the display.

Press **↓** until "RESET TARE TO ZERO" is highlighted.

Press SELECT.

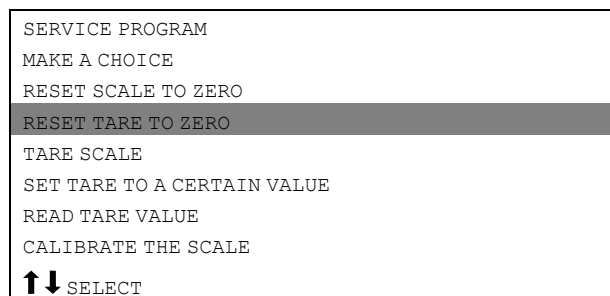

This screen shows that the stored tare parameter has been cleared.



Press SELECT.

6.2.3 Tare scale

For machines with weighing equipment installed only!

This function involves first loading the drum with, for example, a container, then taring (resetting) the weighing equipment so that the weight of the container will not be included when calculating net weight.

If your attempt to tare the weighing equipment fails at this point, you will see an error message equivalent to: "FAILED. PRESS SELECT" on the display.

Press ↓ until "TARE SCALE" is highlighted.

Press SELECT.

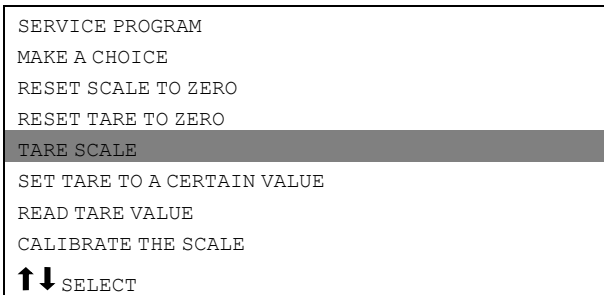

This screen shows that the weighing equipment has been tared successfully.



Press SELECT.

6.2.4 Set tare to a certain value

For machines with weighing equipment installed only!

This function lets you enter a value for the tare parameter, i.e. a weight value which the weighing equipment will disregard when showing a net weight on the display. The function will automatically clear any earlier tare value when you enter a new one.

If your value is not entered successfully at this point, you will see an error message equivalent to: "FAILED. PRESS SELECT" on the display.

Press **↓** until "SET TARE TO A CERTAIN VALUE" is highlighted.

Press SELECT.

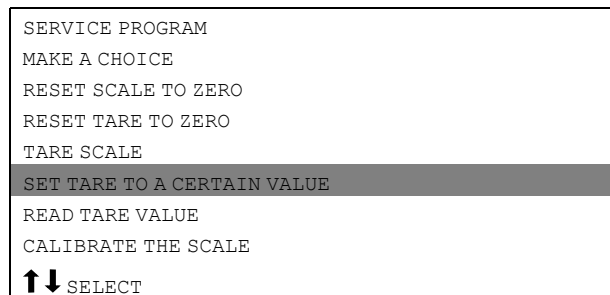

Use the numeric keys to enter the tare you require, unit: hectograms; 1 hectogram = 100 grams.

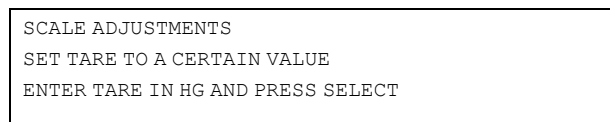

Press SELECT.

This screen shows that the parameter has been entered successfully.



Press SELECT.

6.2.5 Read tare value

For machines with weighing equipment installed only!

This function lets you check the value currently stored as the tare parameter.

Press **↓** until "READ TARE VALUE" is highlighted.

Press SELECT.

```
SERVICE PROGRAM
MAKE A CHOICE
RESET SCALE TO ZERO
RESET TARE TO ZERO
TARE SCALE
SET TARE TO A CERTAIN VALUE
READ TARE VALUE
CALIBRATE THE SCALE
↑↓ SELECT
```

This screen shows the stored tare parameter unit: hectograms (1 hectogram = 100 grams).

```
SCALE ADJUSTMENTS
READ TARE VALUE
10 HG
```

Press SELECT.

6.2.6 Calibrate the scale

For machines with weighing equipment installed only!

Note!

This function is used only on installation of a new scale unit.

The machine must be unladen at the start of calibration, i.e. no water or wash load in the drum.

Press ↓ until "CALIBRATE THE SCALE" is highlighted.

Press SELECT.

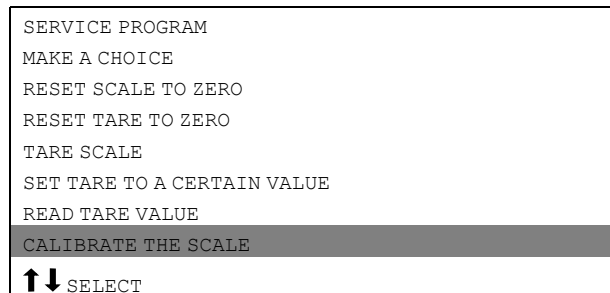

If this calibration has not succeeded you will see an error message equivalent to: "FAILED. PRESS SELECT" on the display.

Set the calibration switch to calibration mode.

Press SELECT.

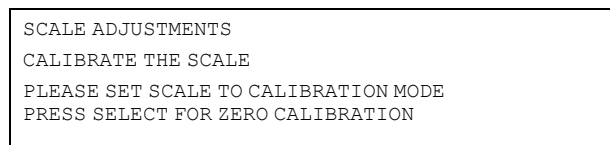

To gain access to the calibration switch in the scale unit, the top panel has to be taken off. Remove the four screws on the scale unit cover. Then the calibration switch can be switched between normal mode "ON" and calibration mode "CAL".

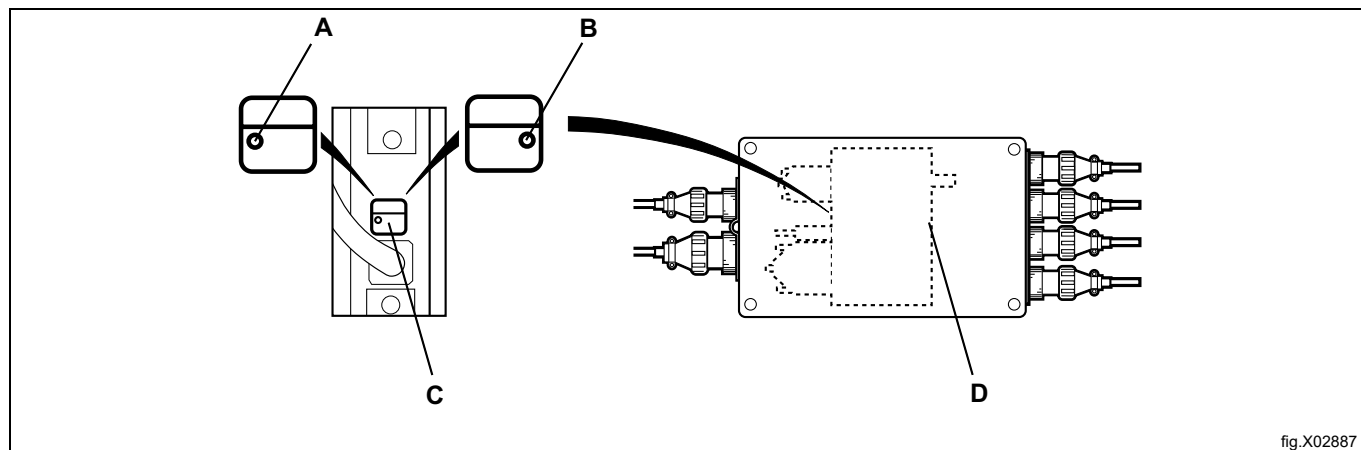

A	ON (normal)
B	CAL (calibration)
C	Calibration switch
D	Scale unit

Press SELECT.

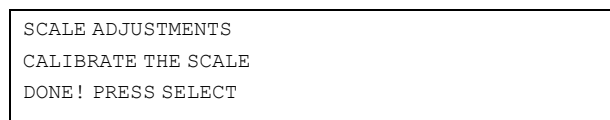

A weight of between 40 kg and 400 kg should be used as a calibration weight.
 The higher the weight (within these limits), the better the weighing accuracy of the machine.
 Put the calibration weight in the drum.

Use the numeric keys to enter the calibration weight in hg (1 hg = 100 grams).

Press SELECT.

SCALE ADJUSTMENTS
 CALIBRATE THE SCALE
 FILL DRUM WITH CALIBRATION WEIGHT
 ENTER WEIGHT IN HG AND
 PRESS SELECT

Press SELECT.

SCALE ADJUSTMENTS
 CALIBRATE THE SCALE
 DONE! PRESS SELECT

Remove the calibration weight.

Press SELECT.

SCALE ADJUSTMENTS
 CALIBRATE THE SCALE
 REMOVE WEIGHT AND PRESS SELECT

If you want to use the "Calibrate zero" function now:

Press SELECT.

SCALE ADJUSTMENTS
 CALIBRATE THE SCALE
 PRESS SELECT FOR ZERO CALIBRATION

Press SELECT.

SCALE ADJUSTMENTS
 CALIBRATE THE SCALE
 DONE! PRESS SELECT

To gain access to the calibration switch in the scale unit, the top panel has to be taken off. Remove the four screws on the scale unit cover. Then the calibration switch can be switched between normal mode "ON" and calibration mode "CAL".

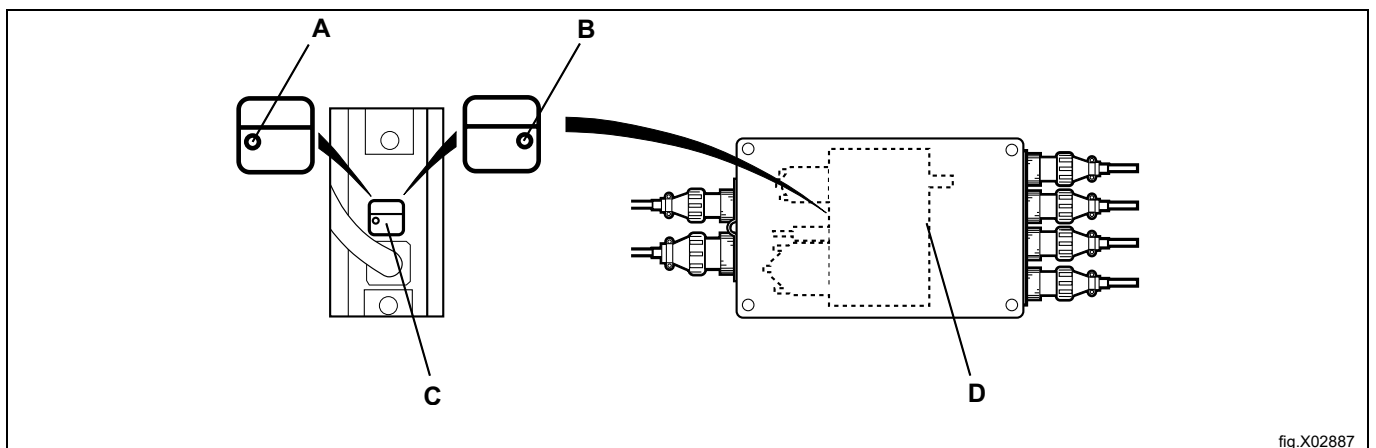

fig.X02887

A	ON (normal)
B	CAL (calibration)
C	Calibration switch
D	Scale unit

Restore the calibration switch to normal mode.

Press SELECT.

SCALE ADJUSTMENTS CALIBRATE THE SCALE RESET SCALE FROM CALIBRATION MODE AND PRESS SELECT

6.2.7 Zero calibration

For machines with weighing equipment installed only!

The "Zero calibration" function is used to increase the accuracy of the weighing equipment. This should be done once a month.

If this calibration has not succeeded you will see an error message equivalent to: "FAILED. PRESS SELECT" on the display.

Note!

The machine must be unladen at the start of calibration, i.e. no water or wash load in the drum.

Press ↓ until "ZERO CALIBRATION" is highlighted.

Press SELECT.

RESET SCALE TO ZERO
RESET TARE TO ZERO
TARE SCALE
SET TARE TO A CERTAIN VALUE
READ TARE VALUE
CALIBRATE THE SCALE
ZERO CALIBRATION
READ VERSION NUMBER
EXIT

If you wish to calibrate zero for the weighing equipment:

Press SELECT.

SCALE ADJUSTMENTS
ZERO CALIBRATION
PRESS SELECT FOR ZERO CALIBRATION

This screen shows you have calibrated zero.

Press SELECT.

SCALE ADJUSTMENTS
ZERO CALIBRATION
DONE! PRESS SELECT

6.2.8 Read version number

For machines with weighing equipment installed only!

In the event of a fault in the weighing equipment (which cannot be put right) make a note of the version number accessed via this function before you contact the supplier's service department.

Press **↓** until "READ VERSION NUMBER" is highlighted.

Press SELECT.

RESET SCALE TO ZERO
RESET TARE TO ZERO
TARE SCALE
SET TARE TO A CERTAIN VALUE
READ TARE VALUE
CALIBRATE THE SCALE
ZERO CALIBRATION
READ VERSION NUMBER
EXIT

The screen shows the version number.

Press SELECT.

SCALE ADJUSTMENTS
READ VERSION NUMBER
STATHMOS AB 3050 REV 00521

7 Memory Card

A memory card is a plastic card, the size of a credit card, with an electronic memory chip inside it (A).

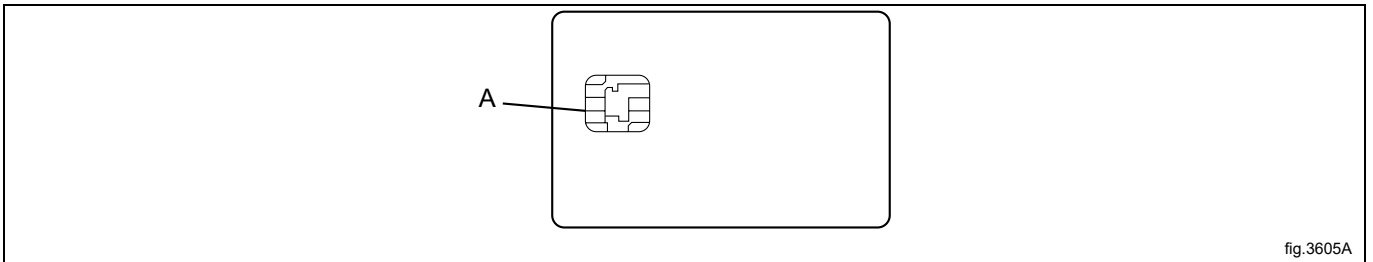

This memory card is capable of storing 10 to 15 wash programs of normal size. If the programs are mostly small ones, more of them can be stored, whereas larger programs will reduce the number which can be held by the memory card. Memory cards of this type can be used to:

- Transfer wash programs from one machine to another.
- Run wash programs straight from the memory card.
- Transfer wash programs from a PC to a memory card and from memory card to a PC (these procedures, and how to write a wash program on a PC, are described in the manual for "Wash Program Manager" (WPM)).

A program stored on a memory card may be given restricted-use status. This means that:

- The program cannot be deleted or copied to the program control unit of a machine.
- You cannot alter the program or inspect the way it is written.
- To run the program you have to have the memory card and to insert it into the program control unit when the program is to be started.

Note!

"Memory card" also can be called "smart card" or "SMC".

Open card

The content of the open card can be downloaded into a machine. The content in a machine can be uploaded to a card. The content can also be downloaded to several machines.

Locked card

The content can not be changed and can not be downloaded to a machine. At operation, the card has to be inserted into the card reader. Program can not be uploaded to the card.

To select the "Memory card" function

Insert the memory card with the chip first, to the left, into the machines card reader (B).

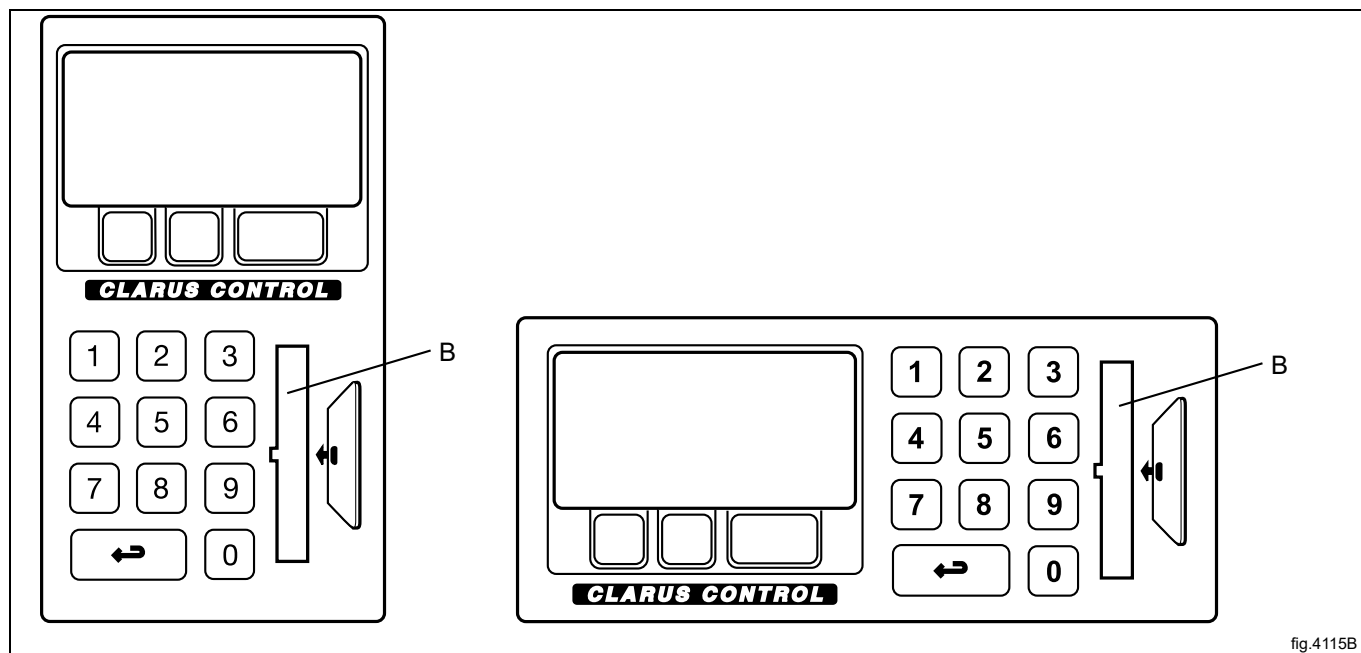
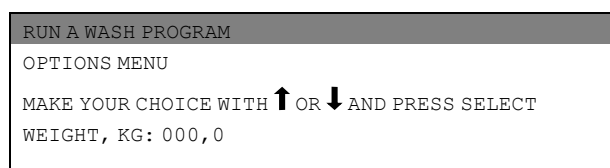



fig.4115B

If this menu is not currently displayed:

Press  repeatedly.



Press  to highlight "OPTIONS MENU".

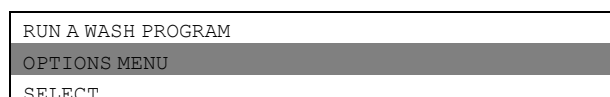

Press SELECT.

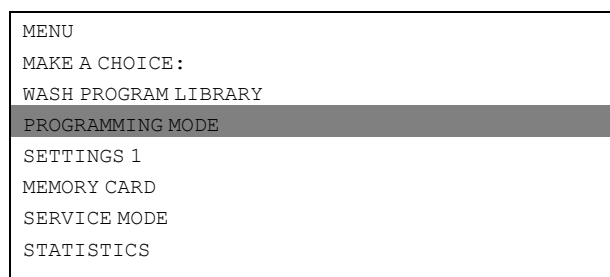

Press **↓** until "MEMORY CARD" is highlighted.

Press SELECT.

WASH PROGRAM LIBRARY
PROGRAMMING MODE
SETTINGS 1
MEMORY CARD
SERVICE MODE
STATISTICS
MANUAL MODE
SETTINGS 2
EXIT

Select the function required using the cursor keys.

Press SELECT.

EXECUTE WASH PROGRAM FROM MEMORY CARD	A wash program can be run from the memory card, without first being copied to the machine. The memory card may be removed from the card reader after the program has started. Programs on memory cards may have "restricted- use" status, which means that they can only be run straight from the memory card, not copied or modified.
COPY PROGRAM FROM MEMORY CARD TO CLS	One or more wash programs can be copied from the memory card to the memory chip in the machine's program control unit. Note that programs on the memory card with "restricted-use" status cannot be copied to the machine memory chip.
COPY PROGRAM FROM CLS TO MEMORY CARD	One or more wash programs can be copied from the memory chip in the machine's program control unit to the memory card. The memory card can hold 10 to 15 wash programs of normal size.
DELETE PROGRAM IN MEMORY CARD	
CLEAR MEMORY CARD	

Execute wash program from memory card

Highlight "EXECUTE WASH PROGRAM FROM MEMORY CARD" (press **↑** if necessary).

Press SELECT.

MEMORY CARD
EXECUTE WASH PROGRAM FROM MEMORY CARD
COPY PROGRAM FROM MEMORY CARD TO CLS
COPY PROGRAM FROM CLS TO MEMORY CARD
DELETE PROGRAM IN MEMORY CARD
CLEAR MEMORY CARD
EXIT

If necessary, use **↓** to highlight the wash program required.

Press SELECT.

991 Start-up program
992 Level check
993 Weight check
994 Temperature check
995 Low extraction 500 rpm, 1 min.
996 Low extraction 500 rpm, 5 min.
997 Extraction 775 rpm

If you want to see the description of the program (where available):

Press TEXT.

To start the program:

Press START.

Once the program has started, the memory card may be removed from the card reader.

To run a program from the memory card

In broad terms, the program control unit has two different memories. One is a "program memory" where all its wash programs are stored, the other is an "operating memory", which is used to hold the program currently in use. The program control unit takes the instructions it needs to run the program from the operating memory.

When a wash program is started, the correct program is retrieved from the program memory and copied into the operating memory.

Program currently being used (A).

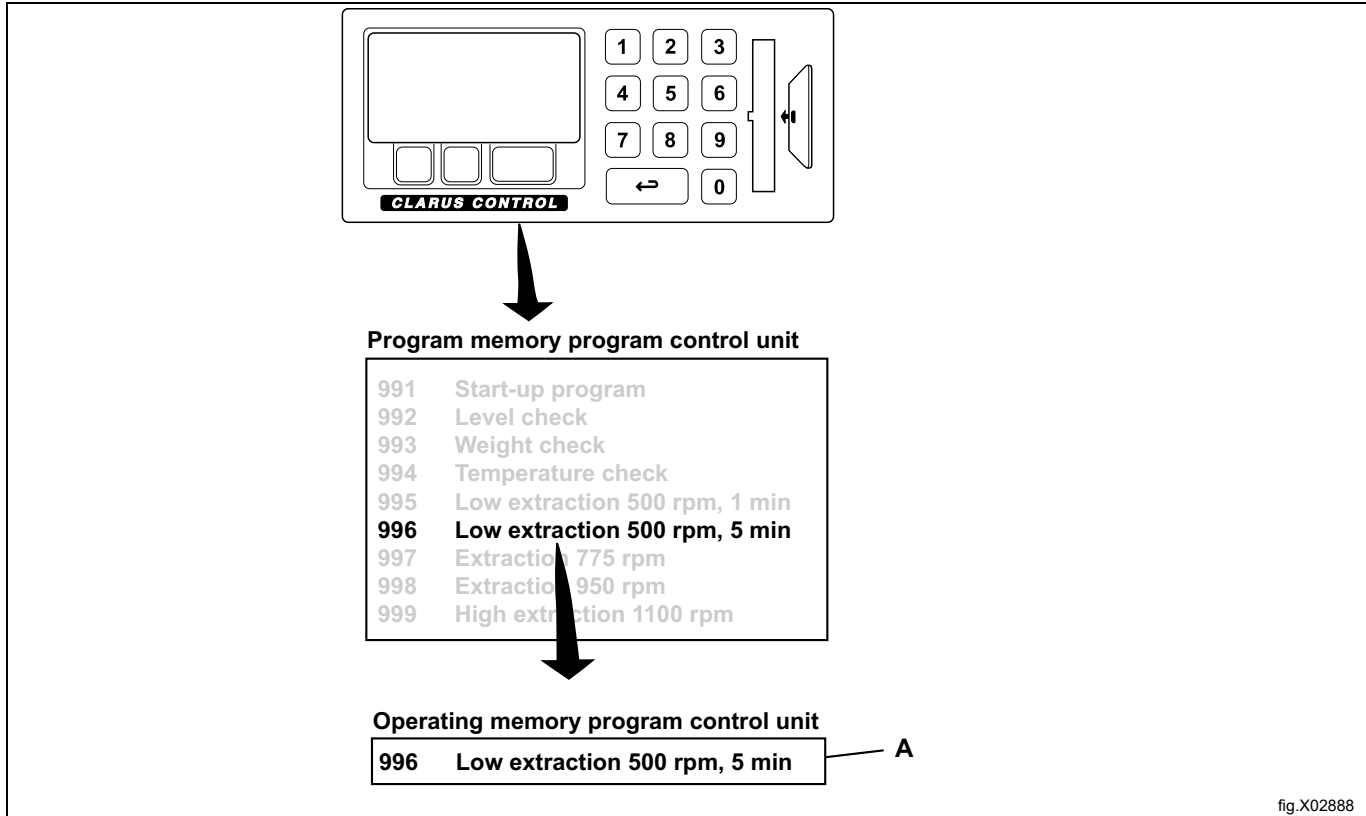

A parallel process takes place when a program is started from a memory card. In other words, the program is copied from the memory card into the operating memory, and the machine runs the program entirely from the set of instructions in the operating memory.

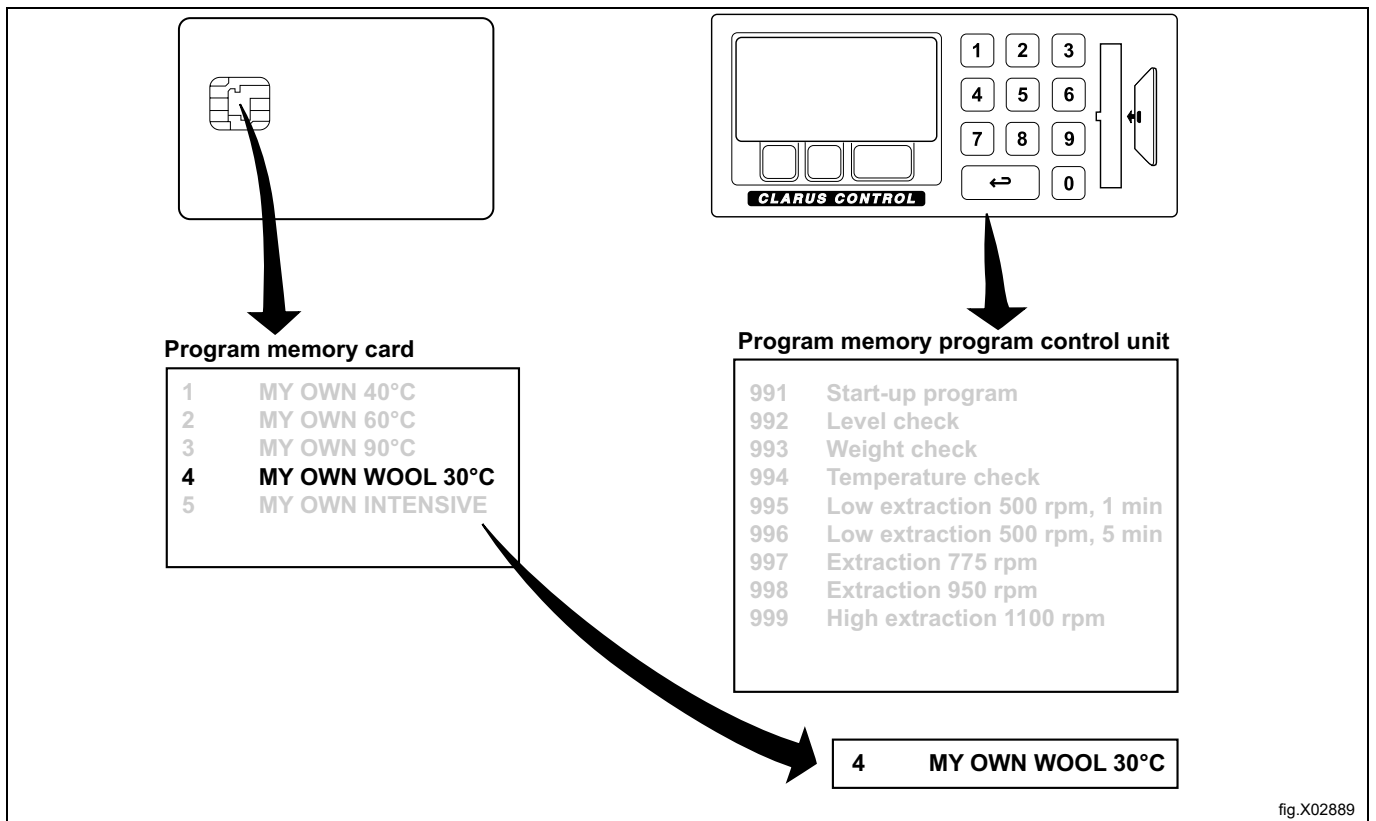

fig.X02889

That is why you may remove the memory card from the card reader once the program has started. Once the program has ended it is erased from the operating memory.

Copy program from memory card to CLS

Note!

Restricted-use programs on a memory card cannot be copied.

A wash program which has been created on a PC can be made a "restricted-use" program. This means that:

- The program cannot be deleted or copied to the program memory of a machine.
- You cannot modify the program or examine its structure.
- To run the program you must have access to the memory card, and insert it into the card reader when the program is to be started.

Highlight "COPY PROGRAM FROM MEMORY CARD TO CLS" (press ↓↑ if necessary).

Press SELECT.

MEMORY CARD
EXECUTE WASH PROGRAM FROM MEMORY CARD
COPY PROGRAM FROM MEMORY CARD TO CLS
COPY PROGRAM FROM CLS TO MEMORY CARD
DELETE PROGRAM IN MEMORY CARD
CLEAR MEMORY CARD
EXIT

If necessary, use ↓ to highlight the wash program required.

Press SELECT.

MY OWN 40°C
MY OWN 60°C
MY OWN 90°C
MY OWN WOOL 30°C
MY OWN INTENSIVE

What happens when a program is copied?

Both the memory card and the program control unit have memory chips capable of storing wash programs. The chip on the card can hold about 10 to 15 programs of normal size, while the chip in the program control unit has a capacity of several hundred programs.

When a program is copied from a memory card to the machine's program control unit, it is copied, not moved (not deleted from the card). A copy is transferred from the chip on the memory card to the storage chip of the machine program control unit.

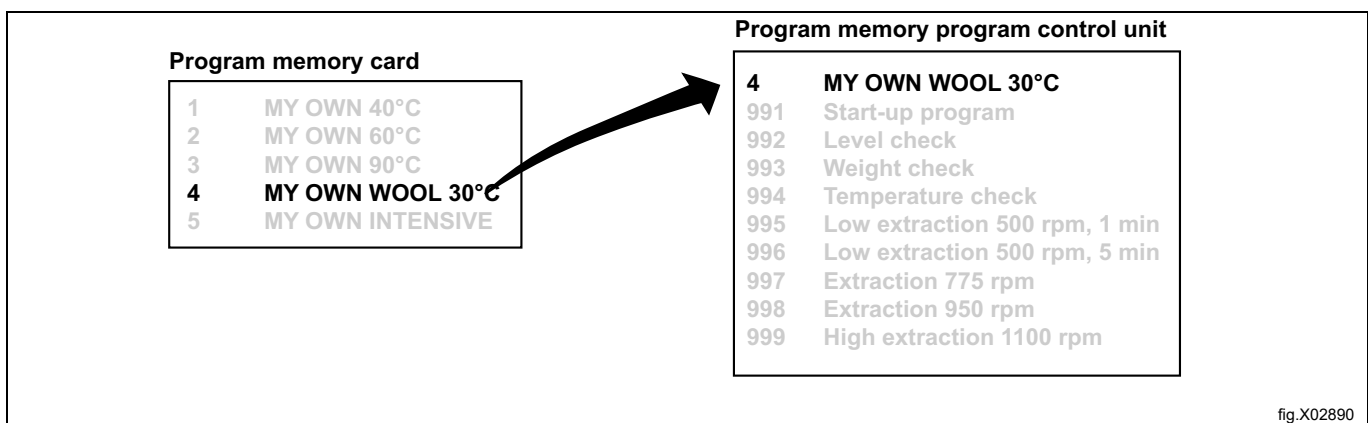

fig.X02890

Choose 1 or 2:

1. If you want to give the program a different program number (from the one it had on the memory card):
Use the numeric keys to enter the new program number, then press SELECT.
2. If the existing number is suitable:
Press SELECT.

If the number you have chosen is already used:

1. Select another number.
Enter the new number and press **SELECT**.
2. Erase the old program number.
Press **SELECT**.

After the program has been copied (it takes only a few seconds) the menu will state: **PROGRAM LOADED**

If you want to copy more programs:

Press any key to continue.

When you have finished:

Press **↓** repeatedly to highlight "EXIT".

Press **SELECT**.

Copy program from CLS to memory card

Highlight "COPY PROGRAM FROM CLS TO MEMORY CARD" (press **↓↑** if necessary).

Press **SELECT**.

MEMORY CARD
EXECUTE WASH PROGRAM FROM MEMORY CARD
COPY PROGRAM FROM MEMORY CARD TO CLS
COPY PROGRAM FROM CLS TO MEMORY CARD
DELETE PROGRAM IN MEMORY CARD
CLEAR MEMORY CARD
EXIT

If necessary, use **↓** to highlight the wash program required.

Press **SELECT**.

991 Start-up program
992 Level check
993 Weight check
994 Temperature check
995 Low extraction 500 rpm, 1 min.
996 Low extraction 500 rpm, 5 min.
997 Extraction 775 rpm

What happens when a program is copied?

Both the memory card and the program control unit have memory chips capable of storing wash programs. The chip on the card can hold about 10 to 15 programs of normal size, while the chip in the program control unit has a capacity of several hundred programs.

When a program is copied from the machine's program control unit to a memory card, it is copied, not moved (not deleted from the machine). A copy is transferred from the storage chip of the machine program control unit to the chip on the card.

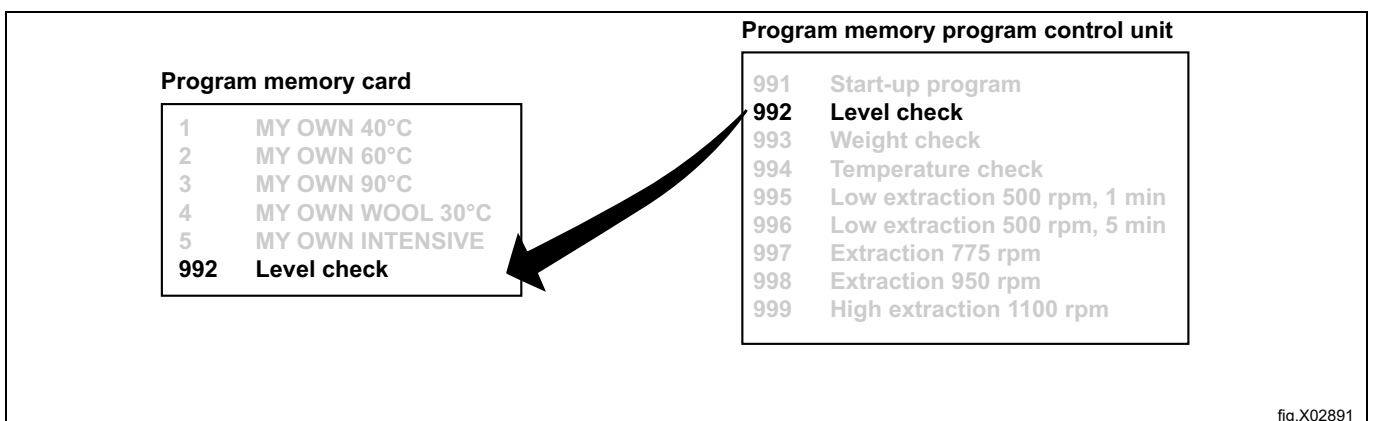

fig.X02891

Choose 1 or 2:

1. If you want to give the program a different program number (from the one it had on the memory card):
Use the numeric keys to enter the new program number, then press **SELECT**.
2. If the existing number is suitable:
Press **SELECT**.

If the number you have chosen is already used:

1. Select another number.
Enter the new number and press **SELECT**.
2. Erase the old program number.
Press **SELECT**.

After the program has been copied (it takes only a few seconds) the menu will state: **PROGRAM LOADED**

If you want to copy more programs:

Press any key to continue.

When you have finished:

Press **↓** repeatedly to highlight "EXIT".

Press **SELECT**.

Delete program in memory card

Note!

Restricted-use programs on a memory card cannot be deleted.

A wash program which has been created on a PC can be made a "restricted-use" program. This means that:

- **The program cannot be deleted or copied to the program memory of a machine.**
- **You cannot modify the program or examine its structure.**
- **To run the program you must have access to the memory card, and insert it into the card reader when the program is to be started.**

Highlight **DELETE PROGRAM IN MEMORY CARD** (press **↓↑** if necessary).

Press **SELECT**.

MEMORY CARD
EXECUTE WASH PROGRAM FROM MEMORY CARD
COPY PROGRAM FROM MEMORY CARD TO CLS
COPY PROGRAM FROM CLS TO MEMORY CARD
DELETE PROGRAM IN MEMORY CARD
CLEAR MEMORY CARD
EXIT

If necessary, use **↓** to highlight the wash program required.

Press **SELECT**.

1 MY OWN 40°C
2 MY OWN 60°C
3 MY OWN 90°C
4 MY OWN WOOL 30°C
5 MY OWN INTENSIVE

The program will now be deleted from the memory card. This takes between 5 and 15 seconds.

If you want to delete more programs:

Continue in the same way as described above.

When you have finished:

Press **↓** repeatedly to highlight "EXIT".

Press **SELECT**.

Clear memory card

Note!

restricted-use programs on a memory card cannot be deleted.

A wash program which has been created on a PC can be made a "restricted-use" program. This means that:

- The program cannot be deleted or copied to the program memory of a machine.
- You cannot modify the program or examine its structure.
- To run the program you must have access to the memory card, and insert it into the card reader when the program is to be started.

Highlight "CLEAR MEMORY CARD" (press ↓↑ if necessary).

Press SELECT.

MEMORY CARD
EXECUTE WASH PROGRAM FROM MEMORY CARD
COPY PROGRAM FROM MEMORY CARD TO CLS
COPY PROGRAM FROM CLS TO MEMORY CARD
DELETE PROGRAM IN MEMORY CARD
CLEAR MEMORY CARD
EXIT

If you change your mind and do not want to delete the entire memory card:

Press any key other than SELECT.

If you want to delete all programs on the memory card (with the exception of any restricted-use programs):

Press SELECT.

8 Maintenance

8.1 Daily

- Clean the door seal and remove detergent residue.
- Check that the door does not leak.
- Clean the detergent compartment and wipe down the machine with a damp cloth.
- Check that the drain valve does not leak.
- Start the machine and check that the door remains locked while the machine is operating. Fast forward the machine to the stop position and check that the door cannot be opened until the program is completed.

Machine with scale:

- Check that panels are mounted.
- Check that no foreign objects are placed on the machine.
- Check that inlet and drain hoses are hanging freely.
- Check 0-weight.

8.2 Every month

- Check that valves, hoses and connections do not leak.
- Remove any textile lint from the drain opening, joints in drain pipes, etc.
- Check the door locking relay.
 - Select program 991 ("Start-up program"). When level is reached, press the emergency stop button. The door lock relay shall open when the water level has drained close to the bottom surface of the inner drum.
 - Reset the emergency stop button and switch power off and on to reset the error message. **Note! The door lock relay must not open immediately.**

8.3 Calibration of level control system

The level control system can be individually and manually calibrated. The calibration starts at the level at the bottom of the inner drum.

The calibration can be made up to 250 mm from the bottom of the inner drum. A ruler is supplied with the machine where the water level above the inner drum can be read.

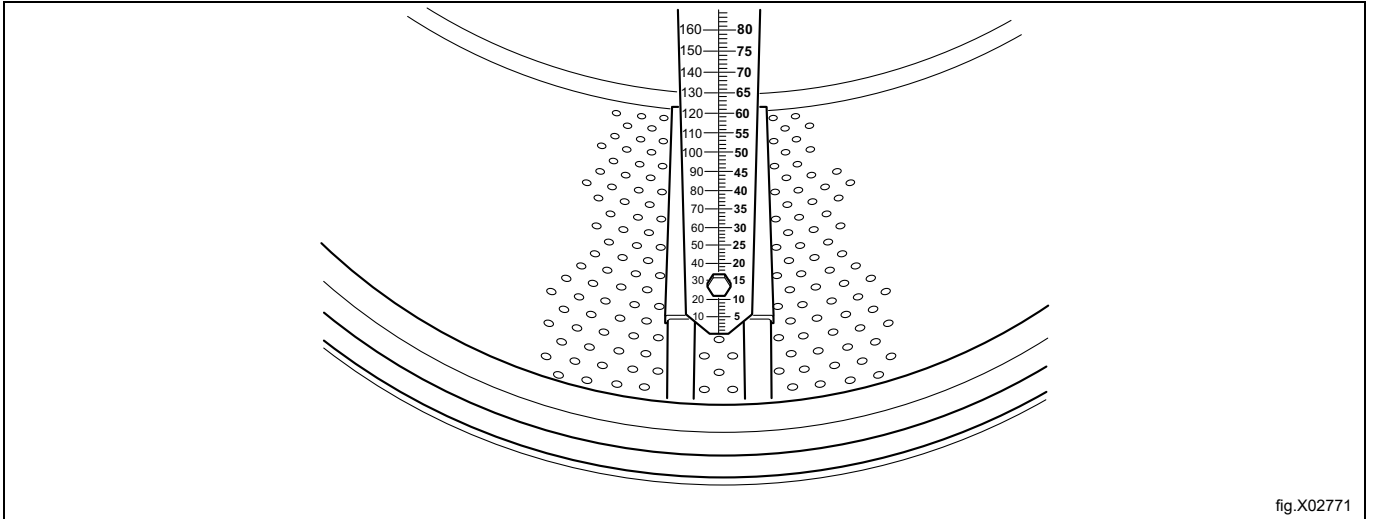

fig.X02771

- Place the ruler on the bottom of the inner drum, equally between two lifters and front and rear gables. Rotate the drum so that the ruler is totally vertical and assure that the three pins of the ruler fit in the holes of the inner drum.
- Push the scale to the bottom of the drum and tighten the nuts.

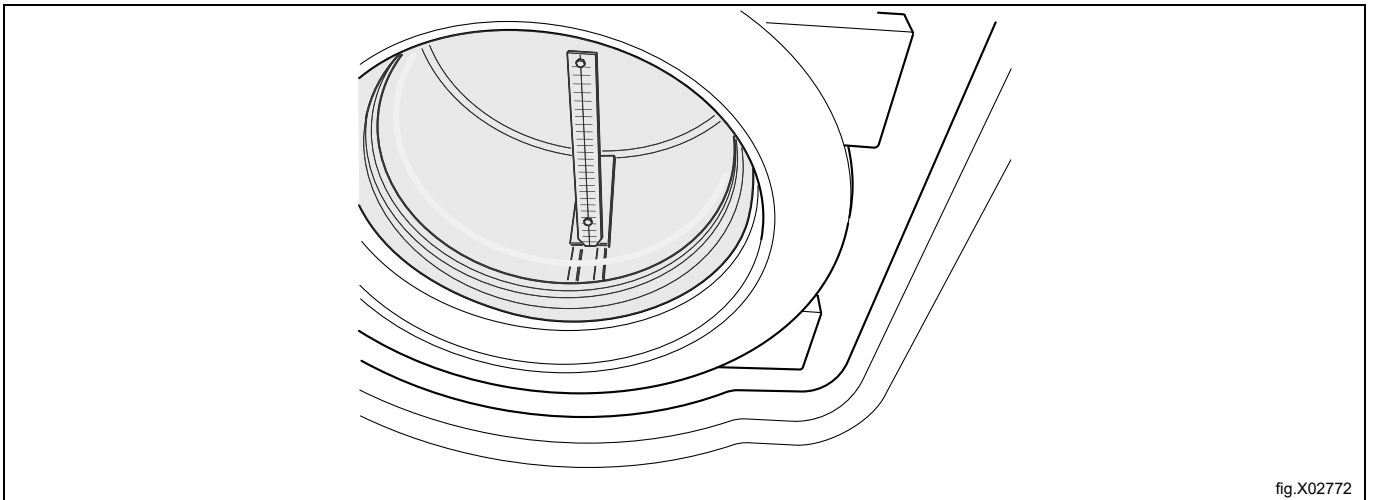
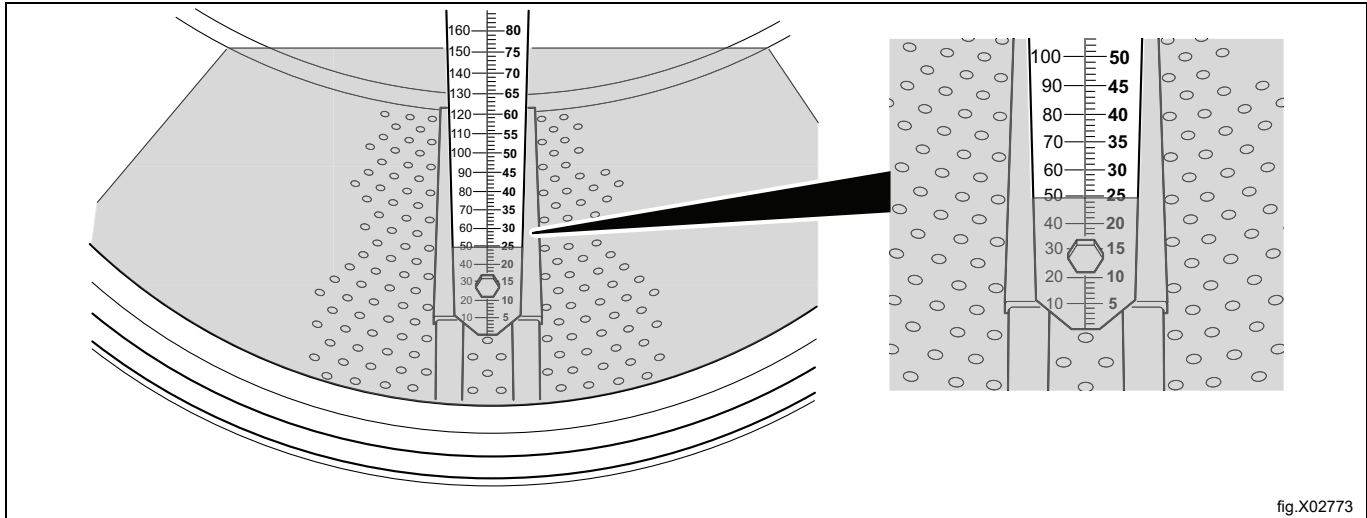

fig.X02772

- Close the door.
- The ruler has two different scales, one in mm and one in RU units (exactly 2 mm/RU units).
The calibration shall be made in at least five level steps, and the first step when the water just enters the inner drum. More calibration steps can be made if requested.
 - Go down to "Options menu"
 - Press "Select"
 - Go down to "Service mode"
 - Press "Select".



```

SERVICE PROGRAM
MAKE A CHOICE:
CLEAR TRIP HOUR COUNTER
CLEAR SERVICE COUNTER
CLEAR WASH PROGRAM COUNTER IN CLS
CLEAR WASH PROGRAM COUNTER IN SMC
SCALE ADJUSTMENTS
CALIB. OF LEVEL SENSOR
EXIT
↑↓ SELECT

```

- "Service Mode" menu is now shown on the display.
- Close the door.
- Go down to "Calibration of level sensor"
- Press "Select"

```

LEVEL CALIBRATION
FILL WATER TO DESIRED LEVEL
LEVEL: 0 SCU

```

- Press "Open" to fill water until the water reaches the bottom of the inner drum where the ruler is placed.
- Press "OK"
- Enter the value read on the ruler in RU units (the first setting is 0=level in drum).
- Press "OK"
- Press "Open" to fill more water.
- Press "OK"
- Enter the value read on the ruler in RU units (if wrong value is entered, press "CLR". Enter new value).
- Press "OK"
- Enter another three values so that it will be five different totally.
- When all values have been entered, press "Save".

```

LEVEL CALIBRATION
OLD CALIBRATION WILL BE OVERWRITTEN
ARE YOU SURE?

```

- Press OK
- Go down to EXIT
- Press SELECT

8.4 Calibration of the scale (weight function)

Zero adjustment of the scale (weight function)

The scale itself is calibrated from factory and no adjustment should be necessary unless some scale parts need to be changed. However a zero adjustment needs to be done as the total weight of the machine needs to be programmed into the scale.

Be sure that the water and drain hoses are in place and properly mounted.

Be sure that all panels are mounted and the cover over the power connection is placed on top of the machine.

- Enter the "service mode" as in level calibration.
- In "service mode" go to "scale adjustment"
- Press "Select"
- Go down to "Zero calibration"
- Press "Select"
- Press "Select" (be sure that there are no extra weight on the machine. And do not lean on the machine)
- When display text "Reset scale from calibration..." appears, press "Select"
- Go down to "Exit"
- Press "Select"
- Go back to main menu.

The zero adjustment is now done and the weight of the empty machine should now be red on the display as 0.0 kg (a difference of ± 0.1 kg is allowed). If an other value is shown in the display, the zero adjustment has to be done again from the start.

8.5 Calibration of the reference machines Wascator FOM 71 CLS

Checklist for calibration of Wascator FOM 71 CLS



Caution



Some of the checkpoints results in exposure to dangerous line voltages or rotating parts and must be carried out only by authorized personnel.

This approval inspection shall be performed at least once a year. All measurement equipment shall be of laboratory type (see list below) with identification labels and checked not more than 12 months prior the testing.

For calibration procedures see list below and the manual following the machine. Follow the instructions and report all values in attached xxxx enclosed to this instruction.

A reference machine passing all the calibration checks will conform with the specification given in IEC 456.

Measurement equipment needed:

- Water level
- Multimeter
- Speedo meter, digital tachometer
- Temperature instrument
- Time watch

Checks to be made**1. Heating element power ***WARNING*****

Remove the front panel and measure the cold resistance of the heating elements. The elements shall be at ambient temperature and the machine should not have been run for at least 5 hours.

Resistance at 20° shall be:

Rated voltage according to Resistance data label attached on machine

400/230 volts 28.5 - 29.7 ohms

415/240 volts 30.9 - 32.2 ohms

2. Visual heating element inspection *WARNING*****

Remove one of the heating elements and visually inspect for and build up of lint, limestone, etc. which can cause reduced heater efficiency.

3. Line voltage *WARNING*****

Measure the rated voltage between L1 - L2 - L3 on the incoming mains to the machine.

4. Leveling of the machine

The machine must be installed on a flat horizontal surface. Check that the top of the machine is horizontal. Measure with a water-level. Deviation from horizontal at any top panel corner must not exceed 5 mm.

5. Drain installation

Check drain installation, minimum drain diameter 50 mm. A drain with a 150 mm free vertical flow is recommended but not compulsory.

6. Water supply

Check of water supply pressure and supply filling rate. Supply pressure shall be between 200 - 600 kPa (2-6 bar). Measure the supply time using the "weight check" program:

FOM 71 CLS Program 993 (18 kgs).

The machines shall be without load.

Supply time to 18 kgs shall be 60 - 75 seconds.

7. Leakage at drain and inlet valve

Check for leakage at drain and inlet valves.

Run weight check program.

Weight 18 kgs. Pause the machine for 15 minutes.

After 15 minutes the weight shall not be changed.

8. Calibration of the internal level scale

Calibrate the level control according to Operating manual.

9. Water level

Water level adjustments and checks.

Use level check programs. The machine shall be without load and not rotating.

Run the level check program 992. The program fills repeatedly to 100, 130, 160 and 200 mm. Read the level of the water at each stop on the internal ruler. Max. deviation ± 5 mm.

10. Weight check

Zero calibrate the machine according to Operating manual. The machine shall be at stand still. Place a calibrated weight of 10 kgs on the top of the machine. Read the scale output. Repeat with an additional 10 kgs. Read the output. Displayed weight shall be within ± 0.1 kg from the calibrated weights.

11. Drain time

Use level check program 992. Fill to 160 mm. Drain the water. Measure the drain time until full flow is reduced.

Max. allowable time 30 seconds.

12. Temperature control

Use temperature control program 994. Put a temperature probe through the upper door gasket into the bath or use the laboratory temperature measurement

system (must be calibrated separately in advance). Read the temperatures at 25°, 40°, 60° and 80° on the machine display and on the measurement instruments.

Max. deviation $\pm 1^\circ\text{C}$.

13. Drum speed at wash. *WARNING*****

Remove the back panel. Run program 991.

The wash speed shall be measured with a speedometer (reflector type).

The reflector shall be placed on the big pulley. Wash speed shall be measured at nominal voltage and with a load of 5 kg of cotton as load.

Speed variation allowable in both directions: 52 ± 1 RPM.

14. Extraction speed *WARNING*****

Proceed as in 13, but rapid advance to last drain after wetting the load and measure the extraction speed with a well balanced load of wet cotton (dry weight 5 kg) after reaching set speed 500 rpm.

Extraction speed shall be within 500 ± 20 RPM.

15. **Recording of complete program (not compulsory)**

Record using the laboratory recording equipment the complete IEC 60° cotton program. For best calibration accuracy use no load.

Parameters to be recorded as a function of time:

Temperature

Amount of water

Speed.

8.6 Door opening for test sample Wascator FOM71 CLS

Open door during wash cycle

It is possible to open the door during a wash cycle in order to take out test samples. But to be able to do so some criteria have to be fulfilled.

- The water level in the machine may not exceed 38 RU when the door is opened.
- The water temp may not exceed 60°C.

Two different pauses are approved for door opening during wash cycle.

- Programmed pause – the pause is programmed in the wash cycle.
- Select "PAUSE" by clicking down in the menu.

9 Disposal information

9.1 Disposal of appliance at end of life

Before disposing of the machine, make sure to carefully check its physical condition, and in particular any parts of the structure that can give or break during scrapping.

The machine's parts must be disposed of in a differentiated way, according to their different characteristics (e.g. metals, oils, greases, plastic, rubber, etc.).

Different regulations are in force in the various countries, therefore comply with the provisions of the laws and competent bodies in the country where scrapping takes place.

In general, the appliance must be taken to a specialised collection/scrapping centre.

Dismantle the appliance, grouping the components according to their chemical characteristics, remembering that the compressor contains lubricant oil and refrigerant fluid which can be recycled, and that the refrigerator and heat pump components are special waste assimilable with urban waste.



The symbol on the product indicates that this product should not be treated as domestic waste, but must be correctly disposed of in order to prevent any negative consequences for the environment and human health. For further information on the recycling of this product, contact the local dealer or agent, the Customer Care service or the local body responsible for waste disposal.

Note!

When scrapping the machine, any marking, this manual and other documents concerning the appliance must be destroyed.

9.2 Disposal of packing

The packing must be disposed of in compliance with the current regulations in the country where the appliance is used. All the packing materials are environmentally friendly.

They can be safely kept, recycled or burned in an appropriate waste incineration plant. Recyclable plastic parts are marked as following examples.

 <p>PE</p>	<p>Polyethylene:</p> <ul style="list-style-type: none"> • Outer wrapping • Instructions bag
 <p>PP</p>	<p>Polypropylene:</p> <ul style="list-style-type: none"> • Straps
 <p>PS</p>	<p>Polystyrene foam:</p> <ul style="list-style-type: none"> • Corner protectors



Electrolux Professional AB
341 80 Ljungby, Sweden
www.electroluxprofessional.com